

# GROVE<sup>®</sup>

# GMK7450

## product guide

 450 tonnes

 60 m

 12 - 73 m

 130 m

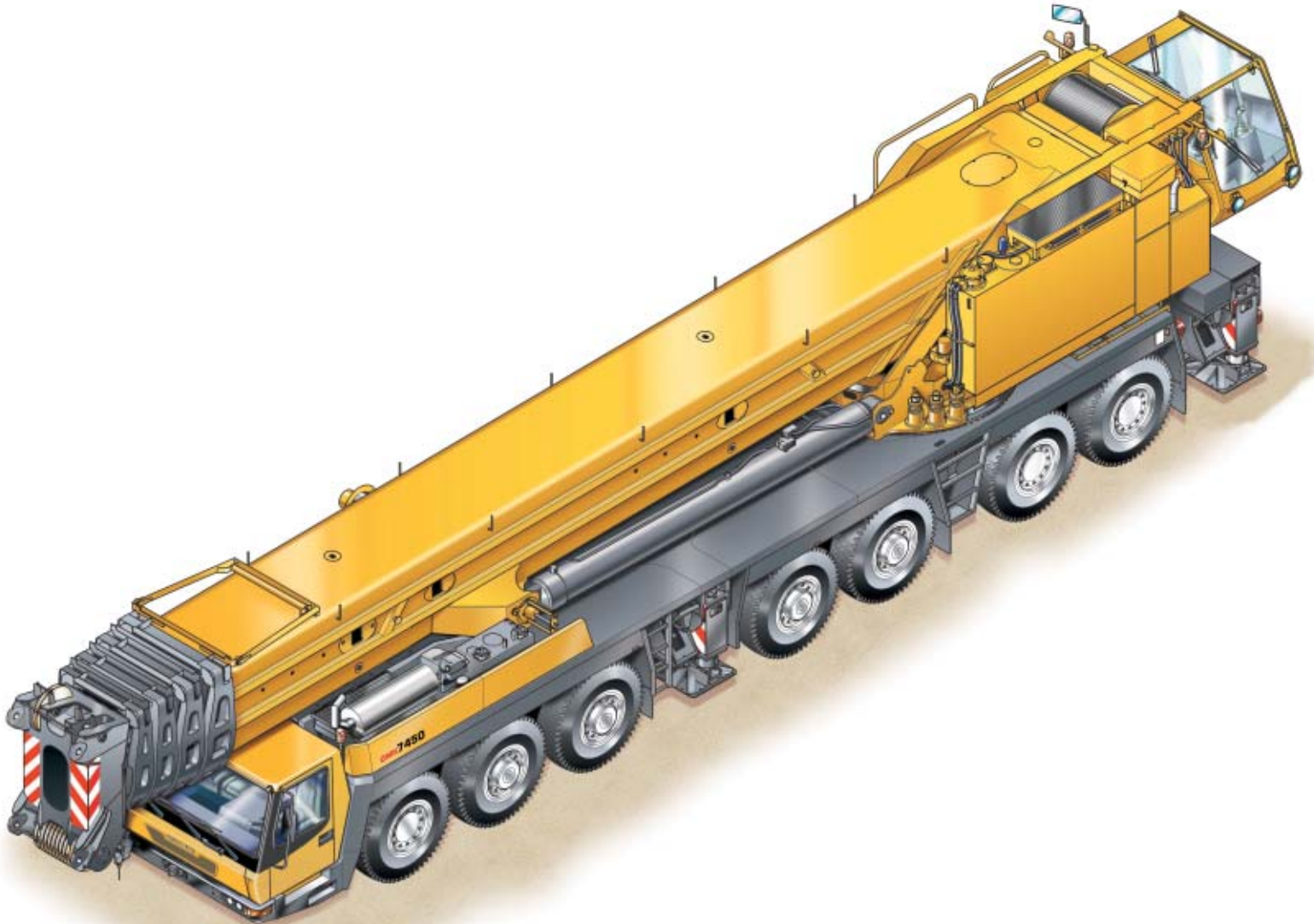

All-Terrain Crane • AT-Kran • Grue Automotrice Routière  
Grúa Todo Terreno Rapida • Gru Fuoristrada Veloci

<b>Specification</b>	<b>3</b>
<b>Technische Daten</b>	<b>4</b>
<b>Caractéristiques techniques</b>	<b>5</b>
<b>Características</b>	<b>6</b>
<b>Caratteristiche</b>	<b>7</b>
<b>Data • Daten • Caractéristiques • Datos • Dati</b>	<b>8</b>
<b>Dimensions • Abmessungen • Encombrement • Dimensiones • Dimensioni</b>	<b>9</b>
Luffing jib • Wippspitzenausleger • Volée variable • Plumín de angulación variable • Jib a volata variable	<b>10</b>
Counterweight • Gegengewicht • Contrepoids • Contrapesos • Contrappesi	<b>12</b>
<b>Load charts • Traglasten • Capacités de levage • Capacidades • Capacità</b>	
Notes • Hinweise • Notes • Notas • Note	<b>13</b>
Working Range • Arbeitsbereiche • Diagramme de levage • Gama de trabajo • Area di lavoro	<b>14</b>
Telescopic Boom • Teleskopausleger • Flèche principale • Pluma telescópica • Braccio telescopico	<b>15</b>
Telescopic boom • Teleskopausleger • Flèche principale • Pluma telescópica • Braccio telescopico (Mega-Wing-Lift)	<b>19</b>
Lattice extension • Auslegerverlängerung • L'extension treillis • Plumín fijo • Jib	<b>22</b>
Luffing jib • Wippspitzenausleger • Volée variable • Plumín de angulación variable • Jib a volata variable	<b>25</b>
Luffing jib • Wippspitzenausleger • Volée variable • Plumín de angulación variable • Jib a volata variable (Mega-Wing-Lift)	<b>36</b>
<b>Notes • Hinweise • Notes • Notas • Note</b>	
Symbols • Symbolerklärung • Glossaire des symboles • Glosario de simbolos • Glossario dei simboli	<b>43</b>



Manitowoc Crane CARE is the Manitowoc Crane Group's unparalleled product support organisation. Manitowoc Crane CARE combines all aspects of parts, service, technical documentation, technical support and training into one organisation. The program includes all of the Manitowoc Crane Group's brands, which include, Potain, Grove, Manitowoc, Manlift and National Crane.

For the care of your crane and the prosperity of your business, Manitowoc Crane CARE is your single source for customer support. Wherever, whenever, whatever – we're there.

Manitowoc Crane CARE vereint alle Serviceleistungen der Manitowoc Crane Group im Produktsupport vor und nach dem Verkauf: Ersatzteile, Service, technische Dokumentation, technischer Support und Schulung, alles unter einem Dach. Dieser Service erstreckt sich auf alle Marken der Manitowoc Crane Group: Potain, Grove, Manitowoc, Manlift und National Crane.

Damit Ihr Kran leistungsfähig bleibt und Ihr Erfolg gesichert ist, bietet Ihnen Manitowoc Crane CARE einen umfassenden Support aus einer Hand. Zu jeder Zeit, an jedem Ort, für jeden Fall – wir sind für Sie da.

Organisation hors pair dédiée au support technique des produits de Manitowoc Crane Group, Manitowoc Crane CARE réunit au sein d'une même entité tous les aspects du service : pièces de rechange, service après-vente, publication technique, assistance technique et formation. Ce programme s'adresse à toutes les marques de Manitowoc Crane Group : Potain, Grove, Manitowoc, Manlift et National Crane.

Pour assurer l'entretien de vos grues et la prospérité de votre entreprise, Manitowoc Crane CARE constitue votre unique interlocuteur du service à la clientèle. Où que vous soyez, quel que soit votre besoin, vous pouvez toujours compter sur nous !

Manitowoc Crane CARE, es la organización post-venta y soporte técnico de Manitowoc Crane Group. Manitowoc Crane CARE combina todos los aspectos de piezas de repuesto, servicio, documentación técnica, apoyo técnico y formación en un único lugar. El programa también incluye todas las ramas Manitowoc Crane Group que engloba Potain, Grove, Manitowoc, Manlift y National Crane.

Para el cuidado de su grúa y la prosperidad de su negocio, Manitowoc Crane CARE, es la forma más sencilla de ayudarle. Donde sea y cuando sea, nosotros estamos allí.

Manitowoc Crane CARE è l'ineguagliabile organizzazione di supporto di Manitowoc Crane Group. Manitowoc Crane CARE gestisce tutte le attività legate a pezzi di ricambio, documentazione tecnica, assistenza tecnica e formazione riunite in un unico punto di riferimento. Questo servizio è attivo per tutti i marchi di Manitowoc Crane Group e precisamente Potain, Grove, Manitowoc, Manlift e National Crane.

Per l'assistenza delle Vostre gru e per la redditività dei Vostri affari, Manitowoc Crane CARE è l'insostituibile Vostra risorsa in questo settore. In ogni posto, tutte le volte, per qualsiasi necessità – noi ci siamo

## Superstructure

### Boom

16,0 m to 60,0 m five section TWIN-LOCK™ boom.  
Maximum tip height 63,0 m.

### Boom elevation

2 cylinder with safety valve, boom angle from -1,2° to +82°.

### Load moment and independent anti-two block system

Graphic display load moment and independent anti-two block system with audio-visual warning and control lever lock-out. These systems provide electronic display of boom angle, length, radius, tip height, relative load moment, maximum permissible load, load indication and warning of impending two-block condition with lock-out hoist function.

### Cab

**Aluminium**, tiltable (approx. 20°), full vision, safety glass, adjustable operator's seat with hydraulic suspension, engine-dependent hot water heater and air conditioning. Armrest-integrated crane controls. Ergonomically arranged instrumentation and crane operating controls. Cab stowed over rear for road travel.

### Slewing

3 slewing gears with axial piston motors, planetary gear, automatic brake with foot operated release switch for free slew.

### Counterweight

120 t, consisting of 20 t base section and 10 t sections. Hydraulic removal system.

### Engine

Mercedes-Benz OM906LA, diesel, 6 cylinders, water cooled, turbocharged, 190 kW (258 HP) at 1800 rpm. (80/1269 EWG - fan rigid). Max. torque: 1100 Nm at 1300 rpm. Fuel tank capacity: 300 l. Engine emission: EUROMOT / EPA / CARB (non road).

### Hydraulic system

5 separate circuits, 3 axial piston variable displacement pumps with electronic power limiting control, 1 axial piston variable displacement pump for slewing and 1 fixed displacement pump for auxiliary gears. Thermostatically controlled oil cooler. Tank capacity: 1570 l.

### Control system

ECOS electronic control of all crane movements using electrical control levers with automatic reset to zero. Integrated with the LMI and engine management system by CAN-BUS.

### Hoist

Axial piston variable displacement motor with planetary gear and brake. Drum rotation indicator.

### Electrical system

Three-phase alternator 28 V/100 A, 2 batteries 12 V/170 Ah.

### \*Optional equipment

Mega-Wing-Lift.

Additional 40 t counterweight to be used with Mega-Wing-Lift (total counterweight 160t).

Heavy duty jib, 4/7,5 m.

Lattice extension, 12 - 70 m, in sections of 6 m. 12 - 42 m offsets 3°, 46 - 70 m offsets 3°, 25°.

Luffing jib, 25 - 73 m, in sections of 6 m.

Auxiliary hoist.

Engine-independent hot water heater, with engine pre-heater.

## Carrier

### Chassis

Special 7-axle chassis, all-welded torsion-resistant box type construction in high strength steel.

### Outriggers

4 double hydraulically telescoping beams with vertical cylinders and outrigger pads. Independent horizontal and vertical movement control on each side of the carrier. Removable rear outrigger box. Electronic level indicator with automatic levelling system.

### Engine

Mercedes-Benz OM502LA, diesel, 8 cylinders, water cooled, turbocharged, 420 kW (571 HP) at 1800 rpm (80/1269 EWG - fan loose). Max. torque: 2700 Nm at 1080 rpm. Fuel tank capacity: 500 l. Engine emission: EUROMOT / EPA / CARB (non road).

### Transmission

Allison automatic HD4076, 7 forward and 1 reverse speed. Transfer case with 2 speeds and inter-axle differential lock.

### Drive/Steer

14 x 6 x 14.

### Axle lines

7 axle lines. 1, 4 and 5 are driven steering axle lines, the 2nd, 3rd, 6th and 7th are steering axle lines.

### Suspension

**MEGATRAK®**. All wheels with independent hydropneumatic suspension and hydraulic lockout. Longitudinal and transverse level control with automatic on-highway levelling system. Range +170 mm/-130 mm.

### Tyres

14 tyres, 14.00 R25.

### Steering

Dual circuit, hydraulic power assisted steering with emergency steering pump. Axle lines 1, 2, 3, 6 and 7 steer on highway. Separate steering of the 4th, 5th, 6th and 7th axle line for all wheel steering and crabbing.

### Brakes

Service brake: pneumatic dual circuit, acting on all wheels, air dryer. Permanent brake: exhaust brake with constant throttle brake and hydraulic transmission retarder. Parking brake: pneumatically operated spring-loaded brake acting on axle lines 2, 4, 5, 6 and 7.

### Cab

**Aluminium**, 2-man-design, safety glass, driver and passenger seat with hydraulic suspension, engine-dependent hot water heater and air conditioning. Complete instrumentation and driving controls.

### Electrical system

Three-phase alternator 28 V/100A, 2 batteries 12 V/170 Ah. Lighting system and signals 24 V.

### \*Optional equipment

14 x 8 x 14.

Electric driveline retarder.

14 tyres, 16.00 R25 (vehicle width 3,00 m).

14 tyres, 20.5 R25 (vehicle width 3,10 m).

Folding bunk bed in carrier cab.

Engine-independent hot water heater, with engine pre-heater.

\*Further optional equipment upon request

## Kranoberwagen

### Teleskopausleger

Von 16,0 m bis 60,0 m ausfahrbarer, fünfteiliger, TWIN-LOCK™ Ausleger. Maximale Rollenhöhe 63,0 m.

### Wippwerk

2 Zylinder mit Sicherheits-Rückschlagventil. Auslegerverstellwinkel -1,2° bis +82°.

### Lastmomentbegrenzer und unabhängiges Hubendschalter System

Grafische Darstellung Lastmomentbegrenzer mit hör- und sichtbarer Vorwarnung sowie automatischer Abschaltung, Digitalanzeige für tatsächliche und zulässige Belastung, Ausladung und diverse Zustände. Unabhängiges Hubendschalter System mit Abschaltfunktion.

### Kranfahrerkabine

Aluminium-Kabine, ca. 20° Kippbar, Vollsicht, Sicherheitsglas, verstellbarer Fahrersitz mit hydraulischer Dämpfung. In Armlehnen integrierte Kransteuereinrichtung. Ergonomisch angeordnete Steuer- und Kontrolleinrichtungen. Motorabhängige Warmwasserheizung und Klimaanlage. Bei Straßenfahrt wird die Kabine zum Heck geschwenkt.

### Drehwerk

3 Drehwerke mit Axialkolbenmotoren, Planetengetriebe, automatische Bremse, Freischaltung über Fußtaster.

### Gegengewicht

120 t, bestehend aus einer 20t Basisplatte und weiteren 10t - Platten. Hydraulisches Rüstsystem.

### Motor

Mercedes-Benz OM906LA, 6 Zylinder Diesel, wassergekühlt mit Abgasturbolader, 190 kW (258 PS) bei 1800 min<sup>-1</sup> (80/1269/EWG Ventilator starr), max. Drehmoment 1100 Nm bei 1300 min<sup>-1</sup>. Kraftstoffbehälter: 300 l. Motoremission: EUROMOT / EPA / CARB (non road).

### Hydrauliksystem

5 getrennte Kreisläufe, 3 Axialkolben-Verstellpumpen mit elektronischer Grenzlastregelung, 1 Axialkolben-Verstellpumpen für das Drehwerk und 1 Konstantpumpe für Nebetriebwerke. Thermostatisch gesteuerter Ölkühler. Tankvolumen: 1570 l Hydrauliköl.

### Steuerung

ECOS elektronische Steuerung aller Bewegungen mit elektrischen Kreuzsteuerhebeln mit automatischer Nullstellung, verbunden mit der LMB und dem Motormanagement System über den CAN-BUS.

### Hubwerk

Axialkolben-Verstellmotor mit Planetengetriebe und Bremse. Hubwerksdrehmelder.

### Elektrische Anlage

Drehstromlichtmaschine 28 V/100 A, 2 Batterien 12 V/170 Ah.

#### \*Zusatzausrüstung

Mega-Wing-Lift.

Zusatzgegengewicht 40 t für Mega-Wing-Lift Betrieb

(Gesamtgegengewicht 160t).

Schwerlastspitze, 4/7,5 m.

Auslegerverlängerung, Gitterkonstruktion 12 - 70 m, in 6 m Abstufungen, 12 - 42 m 3° abwinkelbar, 46 - 70 m 3° und 25° abwinkelbar.

Wippspitzenausleger, Gitterkonstruktion 25 - 73 m, in 6 m Abstufungen. Hilfshub.

Motorunabhängige Warmwasser-Standheizung mit Motorvorwärmung.

## Kranunterwagen

### Rahmen

7-Achs-Spezialfahrzeug, geschweißte, torsionssteife Kastenkonstruktion aus hochfestem Feinkornstahl.

### Abstützung

4 hydraulisch doppelt teleskopierbare Schiebeträgen mit. Abstützzylindern und Abstützplatten, beidseitig vom Unterwagen aus einzeln horizontal und vertikal steuerbar. Demontierbarer Stutzkasten hinten. Elektronische Niveauanzeige mit automatischer Nivellierung.

### Motor

Mercedes-Benz OM502LA, 8 Zylinder Diesel, wassergekühlt mit Abgasturbolader, 420 kW (571 PS) bei 1800 min<sup>-1</sup> (80/1269/EWG Ventilator lose), max. Drehmoment 2700 Nm bei 1080 min<sup>-1</sup>. Kraftstoffbehälter: 500 l. Motoremission: EUROMOT / EPA / CARB (non road).

### Getriebe

Allison Getriebeautomat HD4076, 7 Gänge vorwärts und 1 rückwärts. Verteilergetriebe mit 2 Stufen und Längsdifferentialsperre.

### Antrieb/Lenkung

14 x 6 x 14.

### Achslinien

7 Achslinien, Achsline 1, 4 und 5 gelenkt und angetrieben. Achsline 2, 3, 6 und 7 gelenkt.

### Federung

MEGATRAK®. Alle Räder in Einzelradaufhängung, hydropneumatische Federung und hydraulische Blockierung. Neigungsverstellung in alle Richtungen und automatische Straßenfahrtniveaueinstellung. Federweg +170mm/-130mm.

### Bereifung

14 Reifen, Größe 14.00 R25.

### Lenkung

Zweikreis-Hydrolenkung mit Notlenkpumpe. Während der Straßenfahrt werden die 1., 2., 3., 6. und 7. Achse gelenkt. Separate Lenkung der 4., 5., 6., und 7. Achsline für Allradlenkung und Krabbengang.

### Bremsen

Betriebsbremse: pneumatische Zweikreisbremse, auf alle Räder wirkend, Lufttrockner. Dauerbremse: Motorklappenbremse mit Kontantdrossel und Getriebereiarde. Feststellbremse: druckluftbetätigte Federspeicherbremse auf 2., 4., 5. und 7. Achsline wirkend.

### Fahrerhaus

Aluminium, 2-Mann-Fahrerhaus, Sicherheitsglas, hydraulisch gedämpfter Fahrer- und Beifahrersitz, motorabhängige Warmwasserheizung und Klimaanlage. Kontroll- und Bedienungseinrichtung für Fahrbetrieb.

### Elektrische Anlage

Drehstromlichtmaschine 28 V/100 A, 2 Batterien 12 V/170 Ah, Beleuchtung und Signaleinrichtung 24 V.

#### \*Zusatzausrüstung

14 x 8 x 14.

Elektrische Wirbelstrombremse.

14 Reifen, Größe 16.00 R25 (Fahrzeugbreite 3,00 m).

14 Reifen, Größe 20.5 R25 (Fahrzeugbreite 3,10 m).

Klappliege im Fahrerhaus.

Motorunabhängige Warmwasser-Standheizung mit Motorvorwärmung.

\*Weitere Zusatzausrüstungen auf Anfrage

## Superstructure

### Flèche

Flèche cinq éléments, de 16,0 m à 60,0 m, à télescopage TWIN-LOCK™. Hauteur maximum de tête de flèche 63,0 m.

### Relevage

2 vérins avec clapet anti-retour, angle de relevage de - 1,2° à +82°.

### Contrôleur d'état de charge et dispositif de fin de course haute crochet indépendant

Equipements électroniques de contrôle de charge, graphique, et de fin de course haute crochet indépendants avec dispositifs de signalisation sonore et visuelle et coupure des mouvements. Affichage digital d'angle et de longueur de flèche, de portée, de hauteur de tête de flèche, de moment relatif, de charge maximum autorisée, d'état de charge et d'approche de fin de course haute crochet avec coupure du mouvement de montée de treuil.

### Cabine

Cabine aluminium panoramique, inclinable (environ 20°), vitrages de sécurité, siège réglable avec suspension hydraulique, chauffage à eau chaude alimenté par le moteur et dispositif d'air conditionné. Manipulateurs de commande de grue intégrés dans les accoudoirs. Disposition ergonomique des instruments de contrôle et de conduite. Cabine repliée derrière la machine pour déplacements routiers.

### Orientation

Dispositif d'orientation avec entraînement par trois réducteurs, moteurs hydrauliques à pistons axiaux, frein à serrage automatique et commande d'orientation libre au pied.

### Contrepoids

Contrepoids modulaire de 120 tonnes. Plaque de base de 20 t et éléments de 10 t. Système de dépose hydraulique.

### Moteur

Mercedes-Benz OM906LA, diesel, 6 cylindres turbo, refroidi liquide, 190kW (258 CV) à 1800 min-1. (80/1269 CEE - ventilateur non débrayé). Couple max. 1100 Nm à 1300 min-1. Capacité du réservoir: 300 l. Emissions pollution et fumées EUROMOT / EPA / CARB (hors route).

### Système hydraulique

5 circuits séparés, 3 pompes à pistons axiaux à débit variable avec dispositif de régulation de puissance électronique, 1 pompe à pistons axiaux et débit variable pour l'orientation et 1 pompe à débit fixe pour circuits auxiliaires. Refroidisseur d'huile à commande thermostatique. Volume du réservoir: environ 1570 l.

### Commande

Commande électronique de grue par système ECOS et manipulateurs électriques avec retour automatique au neutre. Ces commandes sont reliées au contrôleur d'état de charge et au dispositif de gestion du moteur thermique par système CAN-BUS.

### Treuil de levage

Entraînement par moteur hydraulique à pistons axiaux, réducteur à planétaires et frein. Indicateur de rotation.

### Installation électrique

Alternateur triphasé 28 V/100 A, 2 batteries 12 V/170 Ah.

### \* Equipements optionnels

Mega-Wing-Lift

Contrepoids supplémentaire de 40 t pour utilisation avec système Mega-Wing-Lift (Contrepoids total 160 t).

Fléchette pour levages lourds 4/7,5 m.

Extension treillis de 12 - 70 m par éléments de 6 m, 12 - 42 m inclinable 3°, 46 - 70 m inclinable 3°, 25°.

Volée variable, construction en treillis 25 - 73 m par éléments de 6 m.

Treuil auxiliaire.

Chauffage autonome à eau chaude avec équipement de préchauffage du moteur.

## Porteur

### Châssis

Porteur spécial, 7 lignes d'essieux, caissonné, mécanosoudé, résistant à la torsion, en acier de haute limite élastique.

### Calage

4 poutres à double télescopage hydraulique, avec vérins verticaux et patins d'appui. Commande indépendante des mouvements verticaux et horizontaux des deux côtés du porteur. Caisson arrière amovible. Indicateur de niveau électronique avec système de mise à niveau automatique.

### Moteur

Mercedes-Benz OM502LA, diesel, 8 cylindres turbo, refroidissement liquide, 420 kW (571 CV) à 1800 min -1 (80/1269 CEE - ventilateur débrayé). Couple max. 2700 Nm à 1080 min-1. Capacité du réservoir : env. 500 l. Emissions pollution et fumées EUROMOT / EPA / CARB (hors route).

### Boite de vitesses

Boîte de vitesses automatique Allison HD 4076. 7 rapports de marche avant et 1 rapport de marche arrière. Boîte de transfert à 2 rapports et dispositif de blocage de différentiels inter-ponts.

### Direction/Transmission

14 x 6 x 14.

### Lignes d'essieu

7 lignes d'essieux. Lignes d'essieu 1, 4, et 5 moto-directrices, lignes d'essieu 2, 3, 6 et 7 directrices.

### Suspension

MEGATRAK®. Toutes les roues sont équipées de dispositifs de suspension hydropneumatique indépendants et de bloqueurs hydrauliques.

Commandes de mise à niveau longitudinal et transversal et dispositif de mise à niveau automatique en position route. Débattement: +170 mm/-130 mm.

### Pneumatiques

14 pneus, 14.00 R25.

### Direction

Direction assistée à double circuit et pompe de secours. Essieux 1, 2, 3, 6 et 7 directionnels sur route. Commande de direction indépendante pour les essieux 4, 5, 6 et 7 pour direction sur toutes les roues marche en crabe.

### Freins

Frein de service: freinage pneumatique à double circuit agissant sur toutes les roues, dessiccateur. Ralentisseur par clapet sur échappement et « 5ème soupape » et ralentisseur hydraulique sur boîte de vitesses.

Frein de stationnement: à serrage par ressort et desserrage pneumatique agissant sur les roues des lignes d'essieux 2, 4, 5, 6 et 7.

### Cabine

Aluminium, 2 places, vitrages de sécurité, siège suspendu hydrauliquement, chauffage à eau chaude alimenté par le moteur, dispositif d'air conditionné. Equipements de conduite et instrumentation complets.

### Installation électrique

Alternateur triphasé 28 V/100 A, 2 batteries 12 V/170 Ah, équipement d'éclairage et de signalisation routière 24 V.

### \* Equipements optionnels

14 x 8 x 14.

Ralentisseur à courants de Foucault.

14 pneus 16.00 R25 (largeur du véhicule 3,00 m).

14 pneus 20.5 R25 (largeur du véhicule 3,10 m).

Banquette repliable dans la cabine porteur.

Chauffage autonome à eau chaude, avec équipement de préchauffage du moteur.

\*Autres équipements optionnels sur demande

## Características

### Superestructura

#### Pluma

De 16,0 m a 60,0 m cinco tramos de telescopaje TWIN-LOCK™. Altura máxima en punta 63,0 m.

#### Elevación de pluma

Dos cilindros con válvula de seguridad. Angulo de pluma desde -1,2° hasta +82°.

#### Sistema Indicador del Momento de Carga y de Final de Carrera del Gancho

Indicador del Momento de Carga y de Final de Carrera del Gancho, con alarma audio-visual y bloqueo automático de las palancas. Este sistema incluye pantalla digital con indicación de ángulo de pluma, longitud, radio, altura de cabeza de pluma, momento de carga relativo, carga máxima permisible, carga real y alarma de fin de carrera del gancho con bloqueo del movimiento de elevación.

#### Cabina

**De Aluminio**, basculable (aprox. 20°), amplia visibilidad, cristales de seguridad, asiento del operador ajustable y con suspensión hidráulica. Calefacción dependiente del motor por agua caliente y aire acondicionado. Controles de la grúa integrados en el apoya-brazos. Controles de operación de la grúa e instrumentación ergonómicamente situados. La cabina se recoge en la parte posterior de la grúa para su desplazamiento por carretera.

#### Giro

Tres reductores de giro con motores de pistón axial, engranaje planetario, freno automático con interruptor de desconexión accionado por pedal para giro libre.

#### Contrapeso

De 120 Tm., placa base de 20 T. y diez secciones de 10 T. Sistema hidráulico para desmontaje.

#### Motor

Diesel Mercedes Benz OM906LA, 6 cilindros, refrigerado por agua, turboalimentado, 190 Kw (258 HP) a 1.800 r.p.m. (80/1269 EWG - ventilador fijo). Par máximo: 1.100 Nm a 1.300 r.p.m. Capacidad del depósito de combustible: 300 litros. Emisión de gases: Según normas EUROMOT / EPA / CARB (fuera de carretera).

#### Sistema hidráulico

Cinco circuitos separados, con tres bombas de pistones axiales y desplazamiento variable, con control electrónico de limitación de potencia, una bomba de pistones axiales y desplazamiento variable para el giro y una bomba de desplazamiento fijo para los engranajes auxiliares. Radiador de aceite con control por termostato. Capacidad del depósito: 1570 litros.

#### Sistema de control

Control completamente electrónico (ECOS) de todos los movimientos de la grúa, usando palancas de control eléctrico con retorno automático a cero. Integrado con el Limitador de Cargas y el sistema de control del motor por un equipo "CAN-BUS".

#### Cabrestante

Motor de desplazamiento variable de pistón axial con engranaje planetario y freno. Indicador de rotación del tambor.

#### Sistema eléctrico

Trifásico con alternador 28V/100A, dos baterías de 12v/170 Ah.

#### \* Equipos opcionales

Mega-Wing-Lift.

Contrapeso adicional de 40 T. para utilizar con el Mega-Wing-Lift (contrapeso total 160 T.).

Plumín de gran capacidad 4/7,5 m.

Plumín de celosía fijo, de 12-70 m en secciones de 6 m, 12-42m angulable 3°, 46-70m angulable 3°, 25°.

Plumín de angulación variable, de 25-73 m en secciones de 6m.

Cabrestante Auxiliar.

Calefacción independiente del motor, por agua caliente, con precalentamiento por motor.

### Chasis

#### Bastidor

Chasis especial de 7 ejes de construcción soldada tipo cajón, resistente a la torsión, en acero de alta resistencia.

#### Estabilizadores

Cuatro dobles vigas telescópicas hidráulicas con cilindros verticales y placas de apoyo. Controles independientes para los movimientos horizontales y verticales, con controles en ambos lados del chasis. Estabilizadores traseros desmontables. Indicador electrónico de nivel con sistema de nivelación automática.

#### Motor

Diesel Mercedes Benz OM502LA, 8 cilindros, refrigerado por agua y turboalimentado, 420 Kw (571 HP) a 1.800 r.p.m. (80/1269 EWG - ventilador desconectado), par máximo: 2700 Nm, a 1.080 r.p.m. Capacidad del Depósito de Combustible: 500 litros. Emisión de gases: Según normas EUROMOT / EPA / CARB (fuera de carretera).

#### Transmisión

ALLISON automática HD4076, 7 velocidades adelante y 1 atrás. Caja de transferencia con 2 velocidades y bloqueo diferencial entre ejes.

#### Tracción/Dirección

14 x 6 x 14.

#### Ejes

7 ejes en línea. Ejes 1, 4 y 5 motrices y directrices. Ejes 2, 3, 6 y 7 directrices.

#### Suspensión

**MEGATRAK®**. Todas las ruedas con suspensión hidroneumática independiente y bloqueo hidráulico. Control de nivel longitudinal y transversal con sistema de nivelación automática en carretera. Desplazamiento +170 mm./ -130 mm.

#### Neumáticos

14 neumáticos, 14.00 R25.

#### Dirección

Dirección servo-asistida con doble circuito con bomba de dirección de emergencia. Los ejes 1, 2, 3, 6, y 7 son directrices para circular por carretera. Dirección separada de los ejes 4°, 5°, 6° y 7° para la dirección en todas las ruedas y conducción tipo cangrejo.

#### Frenos

Frenos de servicio: Neumático con doble circuito, actuando sobre todas las ruedas, secador de aire. Freno continuo: Freno sobre el escape, con estrangulamiento continuo y retardador hidráulico en la transmisión. Freno de Aparcamiento: Accionado neumáticamente y aplicado por muelle sobre los ejes 2°, 4°, 6° y 7°.

#### Cabina

**De Aluminio**, para dos personas, cristales de seguridad, asientos del conductor y pasajero con suspensión hidráulica, calefacción por agua caliente del motor y aire acondicionado. Mandos y panel de instrumentos para la conducción del vehículo.

#### Sistema eléctrico

Trifásico, alternador de 28 V/100A, 2 baterías 12 V/170 Ah. Sistema de alumbrado y señalización a 24 V.

#### \* Equipos opcionales

14 x 8 x 14.

Retardador eléctrico.

14 neumáticos 16.00 R25 (Anchura del vehículo: 3,00 m).

14 neumáticos 20.5 R25 (Anchura del vehículo: 3,10 m).

Litera plegable en la cabina del chasis.

Calefacción independiente del motor por agua caliente, con precalentamiento por motor.

\*Otros opcionales a petición

## Torretta

### Braccio

Da 16,0 a 60 m, 5 sezioni con sfilamento TWIN-LOCK™. Altezza massima 63 m.

### Sollevamento Braccio

2 cilindri idraulici con valvola di blocco, angolo braccio da -1,2° a +82°.

### Limitatore di carico e blocco dei movimenti

Limitatore di carico e blocco dei movimenti con allarme visivo e sonoro e controllo dell'esclusione delle leve. Questo sistema è provvisto di display elettronico riportante l'angolo e la lunghezza dei bracci, il raggio di lavoro, altezza di lavoro, il momento, il peso ammissibile, il peso attuale. Allarme di blocco sui movimenti e sull'argano.

### Cabina

Costruita in alluminio, inclinabile (20° circa), grande visibilità, cristalli di sicurezza, sedile regolabile con sospensione idraulica. Riscaldamento ad acqua dipendente dal motore e aria condizionata. Comandi della gru integrati nei braccioli, strumentazione di controllo e servizio. Cabina ripiegabile per percorsi su strada.

### Rotazione

Ottenuta con riduttore a planetario, freno automatico, pedale azionabile come controllo rotazione.

### Contrappeso

Da 120 ton, diviso in varie sezioni. Sezione base da 20 ton e sezioni supplementari da 10 ton. Sistema di rimozione del contrappeso comandato direttamente dalla cabina.

### Motore

Mercedes Benz OM906LA diesel, 6 cilindri, turbo 190 kW (258 PS) a 1800 giri/min (80/1269 EWG - ventola rigida). Coppia max 1100 Nm a 1300 giri/min. Capacità del serbatoio: 300 litri. Emissioni gassose allo scarico: EUROMOT / EPA / CARB (no su strada).

### Impianto idraulico

5 circuiti separati, 3 pompe a portata variabile con limitazione elettronica, una pompa a portata variabile per la rotazione e una pompa a portata fissa per comandi ausiliari. Raffreddamento olio idraulico con controllo termostatico. Capacità serbatoio 1570 litri.

### Comandi

Tutti i movimenti della gru sono controllati elettricamente con leve di comando a regolazione elettronica con richiamo automatico al punto zero. I comandi sono integrati con il limitatore di carico e motore, e governati dal sistema CAN-BUS.

### Argano

Motore a pistoni assiali con riduttore a planetari e freno automatico. Indicatore di rotazione argano.

### Impianto elettrico

Alternatore trifase 28V/100A, 2 batterie da 12V/170Ah.

### \* Accessori opzionali

Mega-Wing-Lift.

40 ton di zavorra aggiuntiva per utilizzo con il Mega-Wing-Lift (contrappeso totale 160 ton).

Jib corto da 4/7,5 m.

Prolunga a traliccio da 12 a 70 m, composta da sezioni d 6 m.

12-42 inclinabile a 3°, 46-70m inclinabile a 3° e 25°

Prolunga a traliccio a volata variabile da 25 a 73 m, composta da sezioni da 8 m.

Argano ausiliario.

Riscaldamento autonomo con preriscaldatore motore.

## Carro

### Telaio

Carro speciale, 7 assi, costruzione in acciaio scatorato ad alta resistenza, resistente alla torsione.

### Stabilizzatori

4 doppie travi orizzontali con cilindri verticali e piatti d'appoggio, comandi indipendenti dei movimenti orizzontali e verticali sui due lati del carro. Cassa stabilizzatori posteriore rimovibile. Indicatori elettronici di livello con sistema di messa in bolla automatico.

### Motore

Mercedes Benz OM502LA diesel, 8 cilindri, turbo 420 kW (517 PS) a 1800 giri/min (80/1269 EWG - senza ventole). Coppia max 2700 Nm a 1080 giri/min. Capacità del serbatoio: 500 litri. Emissioni gassose allo scarico: EUROMOT / EPA / CARB (no su strada).

### Cambio

Cambio Allison automatico HD4076, 7 marce avanti più una retromarcia. Riduttore ripartitore a due velocità.

### Trazione/Sterzo

14 x 6 x 14

### Assali

7 assi. Gli assi 1, 4 e 5 sono sterzanti e di trazione, assi 2, 3, 6 e 7 solo sterzanti.

### Sospensioni

MEGATRAK®. Tutte le ruote sono montate su sospensioni idropneumatiche indipendenti con bloccaggio idraulico. Controllo del livellamento longitudinale e trasversale con livellamento automatico per la circolazione stradale. Corsa +170mm/-130mm.

### Pneumatici

12 pneumatici montati in singolo 14.00 R25

### Sterzo

Doppio circuito, servoassistito idraulicamente con pompa di emergenza. Con comando per sterzo degli assi 1, 2, 3, 6 e 7. Comando separato per assi 4, 5, 6 e 7 per eseguire la sterzata combinata e a granchio.

### Freni

Freno di servizio: pneumatico a doppio circuito, agente su tutte le ruote, essiccatore aria. Freno di stazionamento: scarico frenato e controllo costante valvola e retarder idraulico. Freno di parcheggio: con molle precaricate a comando pneumatico agente sugli assi 2, 4, 5 e 6.

### Cabina

In alluminio, 2 posti, cristalli di sicurezza, sedile del guidatore e del passeggero con sospensione idraulica, riscaldamento a ricircolo (dipendente dal motore) e aria condizionata. Completa strumentazione di controllo e guida.

### Impianto elettrico

Alternatore trifase 28V/100 A, 2 batterie da 12V 170Ah. Impianto d'illuminazione e segnali a 24V.

### \* Equipaggiamenti opzionali

14 x 8 x 14

Retarder elettrico

Ruote da 16.00 R 25 (Larghezza macchina 3,0m).

Ruote da 20.5 R 25. (Larghezza macchina 3,1m).

Letto pieghevole nella cabina

Riscaldamento autonomo con preriscaldatore motore.

\* Altri a richiesta.



Axle Achse Essieu Eje Asse	1	2	3	4	5	6	7	Total weight Gesamtgewicht Poids total Peso total Peso totale
t	12	12	12	12	12	12	12	84



Lifting Capacity Traglast Force de levage Capacidad de elevación Capacità di sollevamento	Sheaves Rollen Poules Poleas Carrucole	Weight Gewicht Poids Peso Peso	Parts of line Stränge Brins Ramales de cable Numero di funi	Possible load with the crane * Mögliche Traglast am Kran * Capacité possible sur la grue * Carga posible con la grue * Portata ammissibile con la gru *
320 t	11	3500 kg	2 - 18 / ■23	231 t / 277 t ■
250 t	9	3000 kg	2 - 18	231 t
200 t	7	2400 kg	2 - 15	184 t
160 t	5	1800 kg	2 - 11	136 t
100 t	3	1300 kg	2 - 7	88 t
40 t	1	850 kg	1 - 3	38 t
16 t	H/B	450 kg	1	12,5 t

■ requires additional boom nose sheave, Zusatzausrüstung am Rollenkopf erforderlich, demande d'utiliser une poulie auxiliaire de tête de flèche, requiere polea adicional en la cabeza de pluma, è richiesto un blocco di carrucole ausiliario in testa braccio.  
\* varies depending on national regulations, variiert je nach Ländvorschrift, fonction des réglementations nationales, varia dependiendo de las normas nacionales, varia in funzione delle normative nazionali.



+

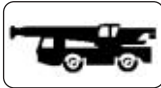

	1	2	3	4	5	6	7	R	
km/h	8,1	17,5	32,2	43,0	61,5	83,0	85,0	12,8	32%
km/h	5,6	12,0	22,1	29,5	42,2	57,0	65,9	8,8	36%
	14.00 R 25								



+



	Infinitely variable stufenlos progressivament variable Infinitamente variable Infinitamente variabile	Rope Seil Cable Cable Fune	Max. Single line pull Max. Seilzug Effort maxi au brin simple Tiro máximo por ramal Tiro max. per singola fune
	0 - 130 m/min single line für einfachen Strang brin simple ramal simple tiro a fune singola	24 mm/460 m	125 kN
	0 - 130 m/min single line für einfachen Strang brin simple ramal simple tiro a fune singola	24 mm/690 m	109 kN
	0 - 1,1 min <sup>-1</sup>		
	- 1,2° to + 82°	approx. 130 s ca. 130 s env. 130 s aproximadamente 130 s aproximadamente 130 s	
	16 m to 60 m	approx. 420 s ca. 420 s env. 420 s aproximadamente 420 s aproximadamente 420 s	



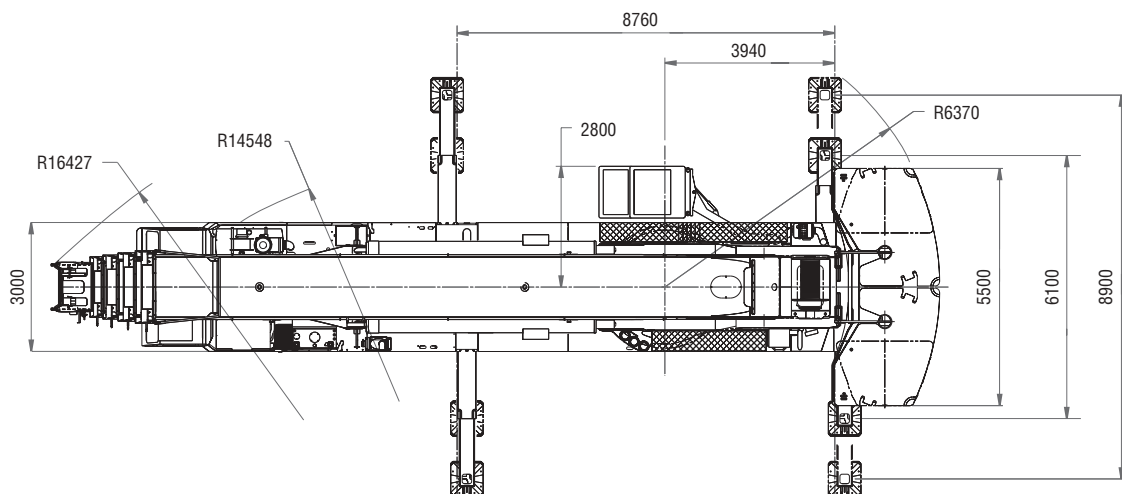
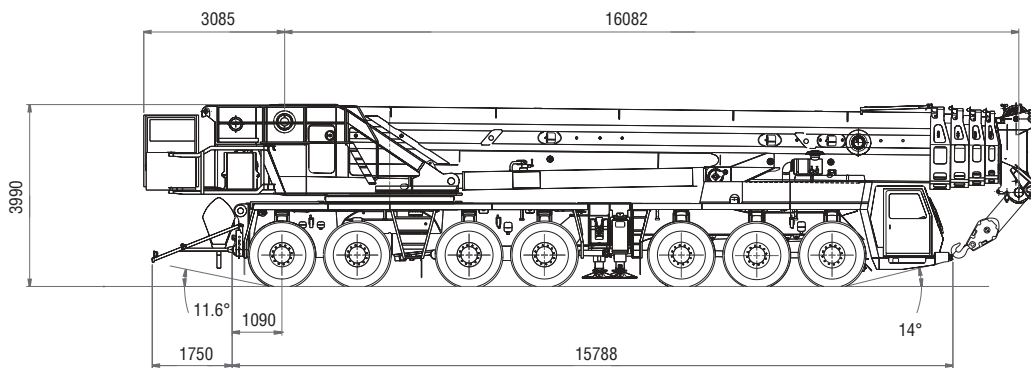
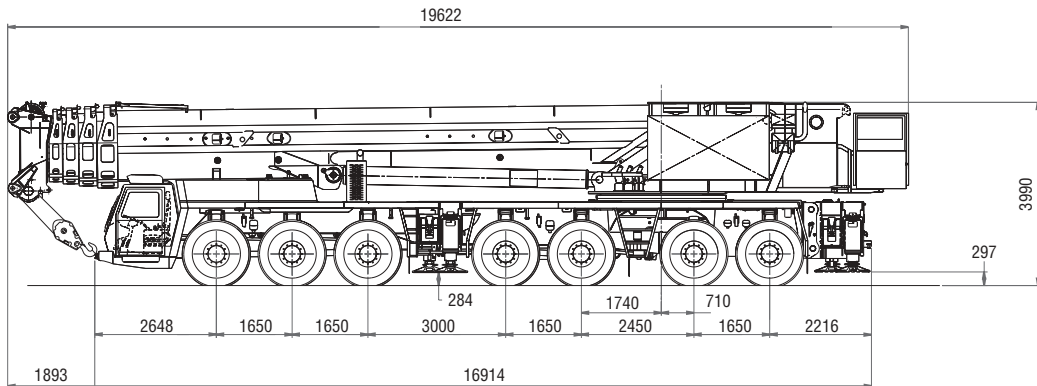

10

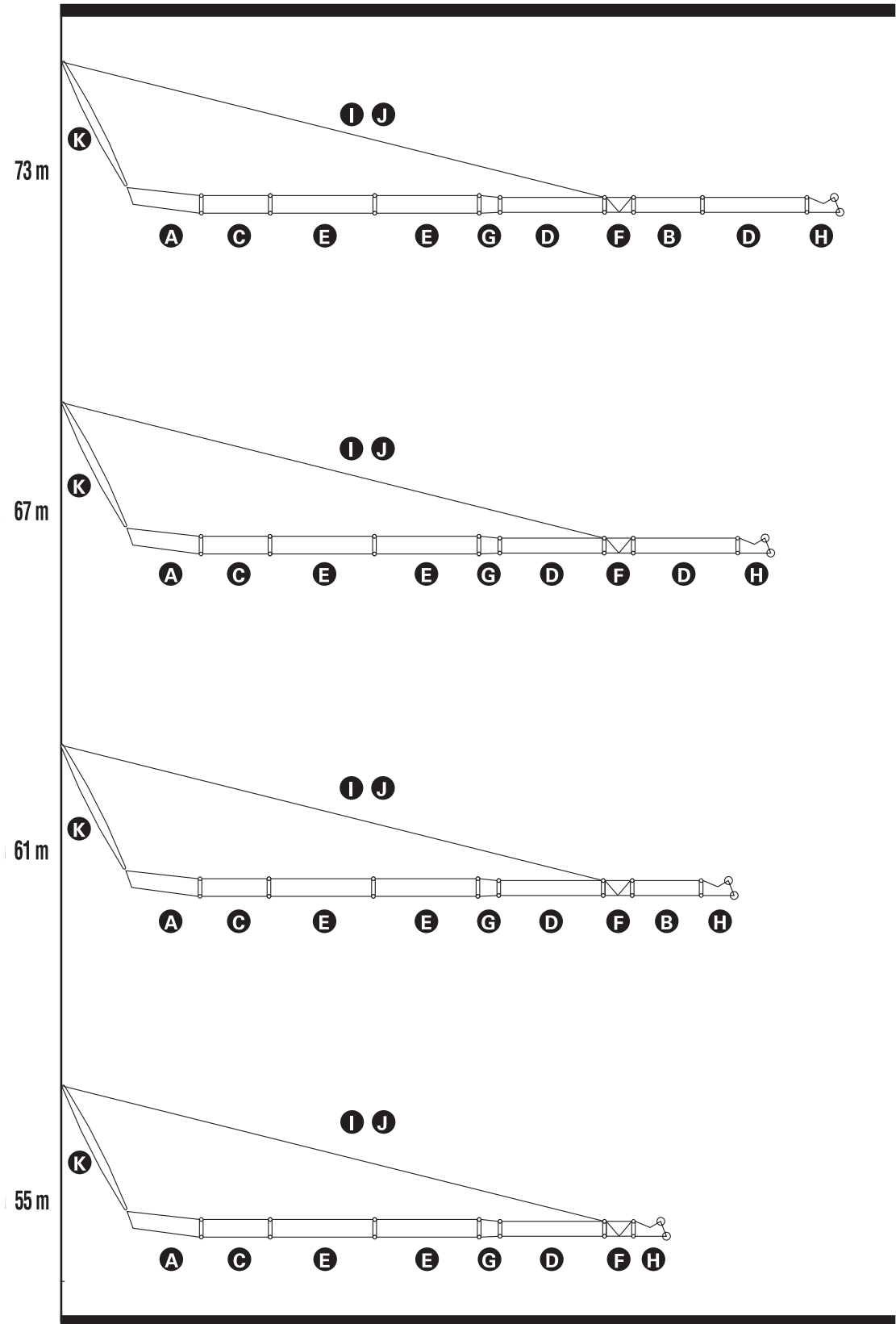

GMK7450

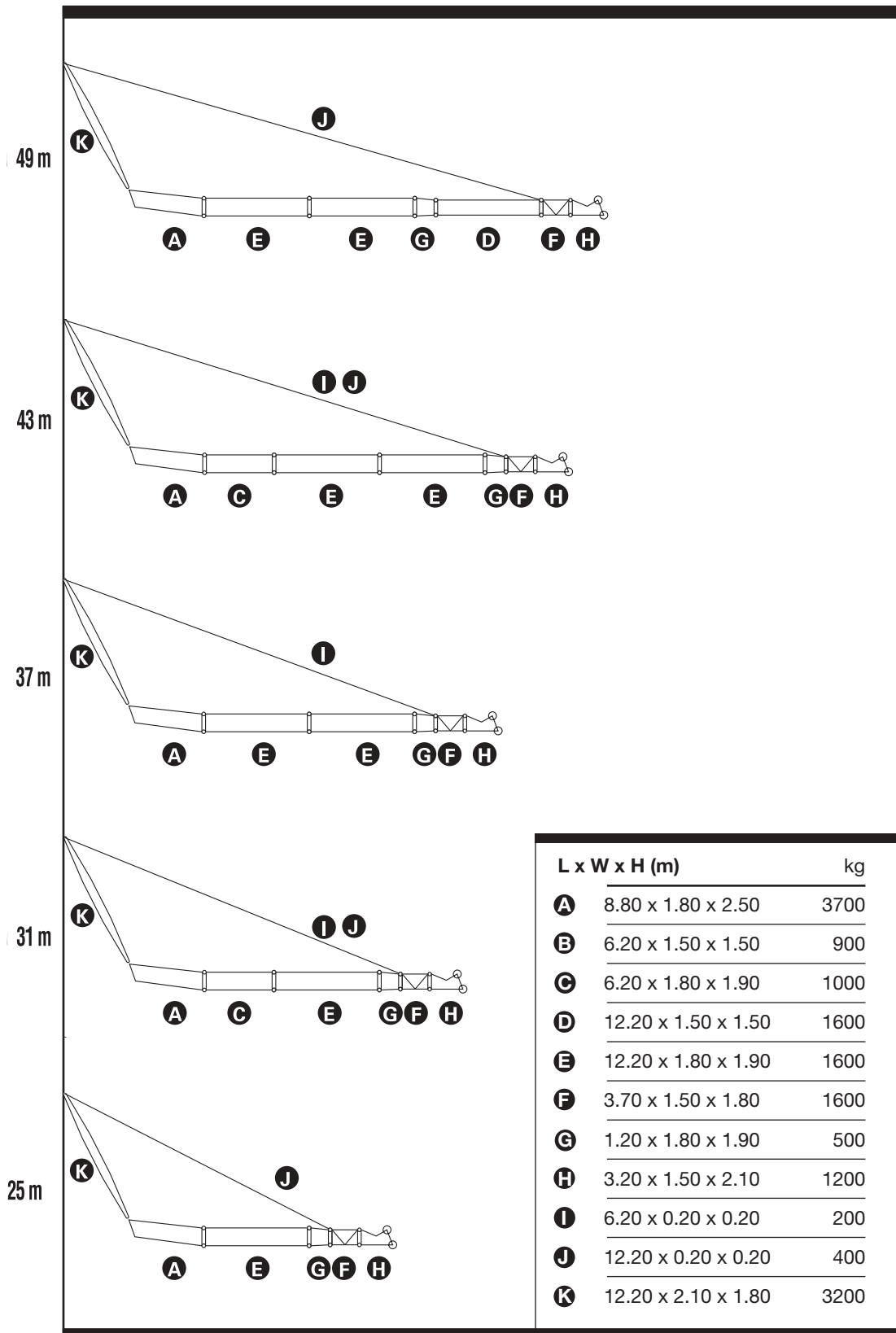

12

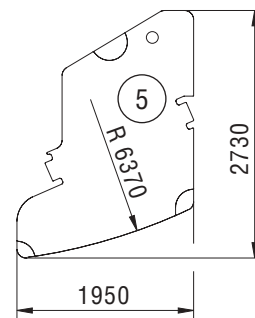
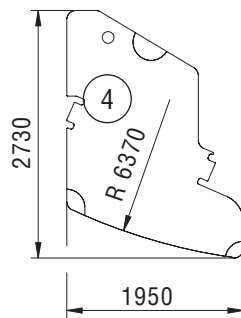
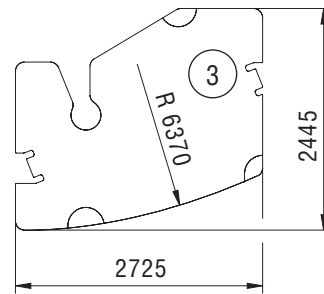
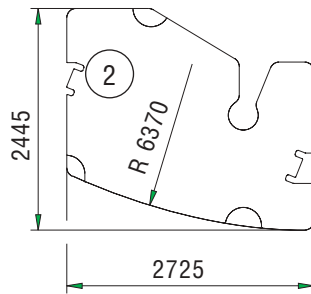
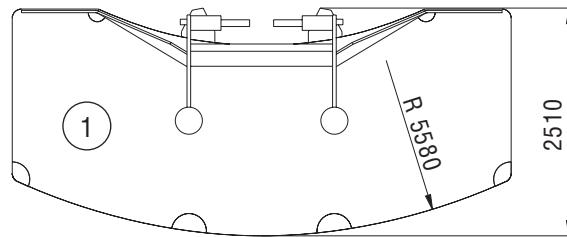
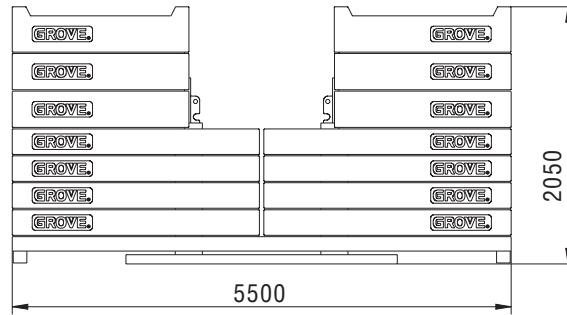

	1 20 t	2 10 t	3 10 t	4 10 t	5 10 t
20 t	x				
40 t	x	x	x		
60 t	x	2 x	2 x		
80 t	x	3 x	3 x		
100 t	x	4 x	4 x		
120 t	x	4 x	4 x	x	x
140 t	x	4 x	4 x	2 x	2 x
160 t	x	4 x	4 x	3 x	3 x

GMK7450

### Lifting capacities according to DIN/ISO • 85%

**WARNING: THIS CHART IS ONLY A GUIDE. The Notes below are for illustration only and should not be relied upon to operate the crane. The individual crane's load chart, operating instructions and other instruction plates must be read and understood prior to operating the crane.**

DIN/ISO: The structural analysis is based on DIN 15018, part 2 and 3 as well as on FEM 5004 standards. Tipping conditions are governed by DIN 15019, part 2 and ISO 4305 standards. They also take into account the requirements of prEN 13000: 2003 and therefore comply with the requirements of the EU Machinery Directive.

85%: The lifting capacities are based on ANSI/ASME B30.5 and do not exceed 85% of the tipping load. Certain dynamic influences and wind require reduction of capacity. Lifting capacities at 85% do not comply with the essential health and safety requirements of the EU Machinery Directive.

The lifting capacities in the load charts are indicated in metric tonnes.

Lifting capacity = payload + weight of the hook block and suspending device.

The lifting capacities for the telescopic boom apply without jibs (swingaway lattice, boom extension, luffing-jib, MWL etc.)

The lifting capacities are subject to modifications.

### Traglasten entsprechen DIN/ISO • 85%

**WARNUNG: DIESE TABELLE IST LEDIGLICH EINE RICHTLINIE. Die Hinweise dienen als Erklärung und sind für die Kranbedienung nicht maßgebend. Vor Inbetriebnahme des Kranes sind die zugehörigen Traglasttabellen, Bedienungsanleitung und andere Vorschriften eingehend zu studieren.**

DIN/ISO: Der Festigkeitsberechnung liegen die DIN 15018 Teil 2 und 3 sowie die FEM 5004 zugrunde. Die Traglasten im Standsicherheitsbereich entsprechen DIN 15019 Teil 2 und ISO 4305. Sie berücksichtigen außerdem die Forderungen der prEN 13000: 2003, und entsprechen damit den Anforderungen der Maschinenrichtlinie.

85%: Die Traglasten basieren auf der ANSI/ASME B30.5 und überschreiten nicht 85% der Kipplast. Wind und dynamische Einflüsse reduzieren die Traglast. Die 85% Traglasten entsprechen nicht den Sicherheitsanforderungen der EG-Maschinenrichtlinie.

Die Traglasten in den Tabellen sind in metrischen Tonnen angegeben.

Traglast = Nutzlast + Eigengewicht der Hakenflasche und der Anschlagmittel.

Die Traglasten für den Teleskopausleger gelten ohne Spitzenanbauten (Klappspitze, Vorbauspitze, Wippspitze, MWL etc.)

Änderungen der Tragfähigkeit vorbehalten.

### Capacités de levage selon DIN/ISO • 85%

**ATTENTION: CE TABLEAU N'EST QU'UN GUIDE. Les notes ci-dessous sont données à titre d'exemple et ne devront pas être utilisées pour faire fonctionner la grue. Toute la documentation concernant chaque type de grue: tableau des charges, instructions de fonctionnement et toutes autres plaques d'instructions devront être lues et comprises avant de manoeuvrer la grue.**

DIN/ISO: Le calculs de résistance sont basés sur les normes DIN 15018, sections 2 et 3 et FEM 5004. Les calculs de basculement sont basés sur les normes DIN 15019, section 2 et ISO 4305. Elles tiennent également compte des paramètres établis par la norme en projet prEN 13000: 12003 et de ce fait satisfont les exigences de la Directive Européenne Machines.

85%: Les capacités de levage sont basées sur les normes ANSI/ASME B30.5 et ne dépassent pas 85% de la charge de basculement. Les conditions de vente et les effets dynamiques réduisent les capacités de levage. Les capacités de levage à 85% ne respectent pas les préconisations concernant la santé et la sécurité prévues par la Directive Machines CE.

Les capacités de levage dans les tableaux sont indiquées en tonnes métriques.

Capacité de levage = charge utile + poids des moufle/crochet et accessoires.

Les capacités de levage pour la flèche télescopique s'entendent sans allonges (flèche, flèche pliante, volée variable, MWL, etc.)

Modifications des capacités de levage réservées.

### Capacidades de elevación de acuerdo con DIN/ISO • 85%.

**AVISO: ESTA TABLA ES SOLO UNA ORIENTACION. Las notas que aparecen al final de la misma solo sirven de ilustración y no deben ser tomadas como instrucciones para operar la grúa. La tabla de cargas, las instrucciones de operación y otras placas ilustrativas de cada grúa deben ser leídas y correctamente interpretadas antes de operar la grúa.**

DIN/ISO: Los análisis de resistencia están basados en las normas DIN 15018, apartados 2 y 3 así como en las normas FEM 5004. Las condiciones de vuelco están reguladas por las normas DIN 15019 apartado 2 y ISO 4305. Tienen también cuenta de las exigencias establecidas por prEN 13000: 2003 y así cumplen con los requerimientos de las Directivas de Maquinaria de la UE.

85%: Las capacidades de elevación están basadas en las Normas ANSI/ASME B30.5 y no exceden del 85% del momento de vuelco. Ciertas influencias dinámicas y el viento requieren una reducción de las capacidades. Las capacidades de elevación al 85% no cumplen con las normas de seguridad exigidas por las Directivas de Maquinaria de la CEE.

Las capacidades de elevación en las tablas están referidas en Tm.

Capacidad de elevación = Carga + peso del gancho y aparejos de carga.

Las capacidades de elevación para la pluma telescópica sin plumines (plegables, extensiones de pluma, angulables por motor, MWL, etc.)

Las capacidades de elevación están sujetas a modificación.

### Capacità di sollevamento in accordo con DIN/ISO • 85%

**ATTENZIONE: QUESTA TABELLA E' SOLO UNA GUIDA. Le note qui sotto riportate sono date a titolo d'esempio e non devono essere utilizzate per operare la gru. La tabella di carico, le istruzioni d'uso ed ogni altro foglio illustrativo devono essere letti e compresi prima di manovrare la gru.**

DIN/ISO: il calcolo di resistenza è basato sulle norme DIN 15018, parte 2 e parte 3 come sugli standard FEM5004. Le condizioni di ribaltamento sono regolate dalle norme DIN 15019 parte 2 e gli standard ISO 4305. Esse tengono conto anche dei parametri stabiliti da prEN13000: 2003 e quindi soddisfano le richieste della Direttiva Macchine Europea.

85%: Le capacità di sollevamento sono conformi alla norma ANSI/ASME B30.5 e non superano l'85% del carico di ribaltamento. Alcuni fattori dinamici e l'azione del vento richiedono una riduzione di portate. Le capacità di sollevamento calcolate all'85% non sono conformi con i requisiti essenziali di salute e sicurezza della Direttiva Macchine CE.

I carichi nelle tabelle di portata sono espressi in tonnellate metriche.

I carichi indicati nelle tabelle non comprendono il peso dei ganci, dei tiranti, e di nessun altro accessorio di sollevamento.

I carichi indicati nelle tabelle sono validi per il braccio telescopico senza falconi o estensioni del braccio.

I carichi indicati sono soggetti a modifiche.

14



16,0 – 60,0 m



8,9 m



360°

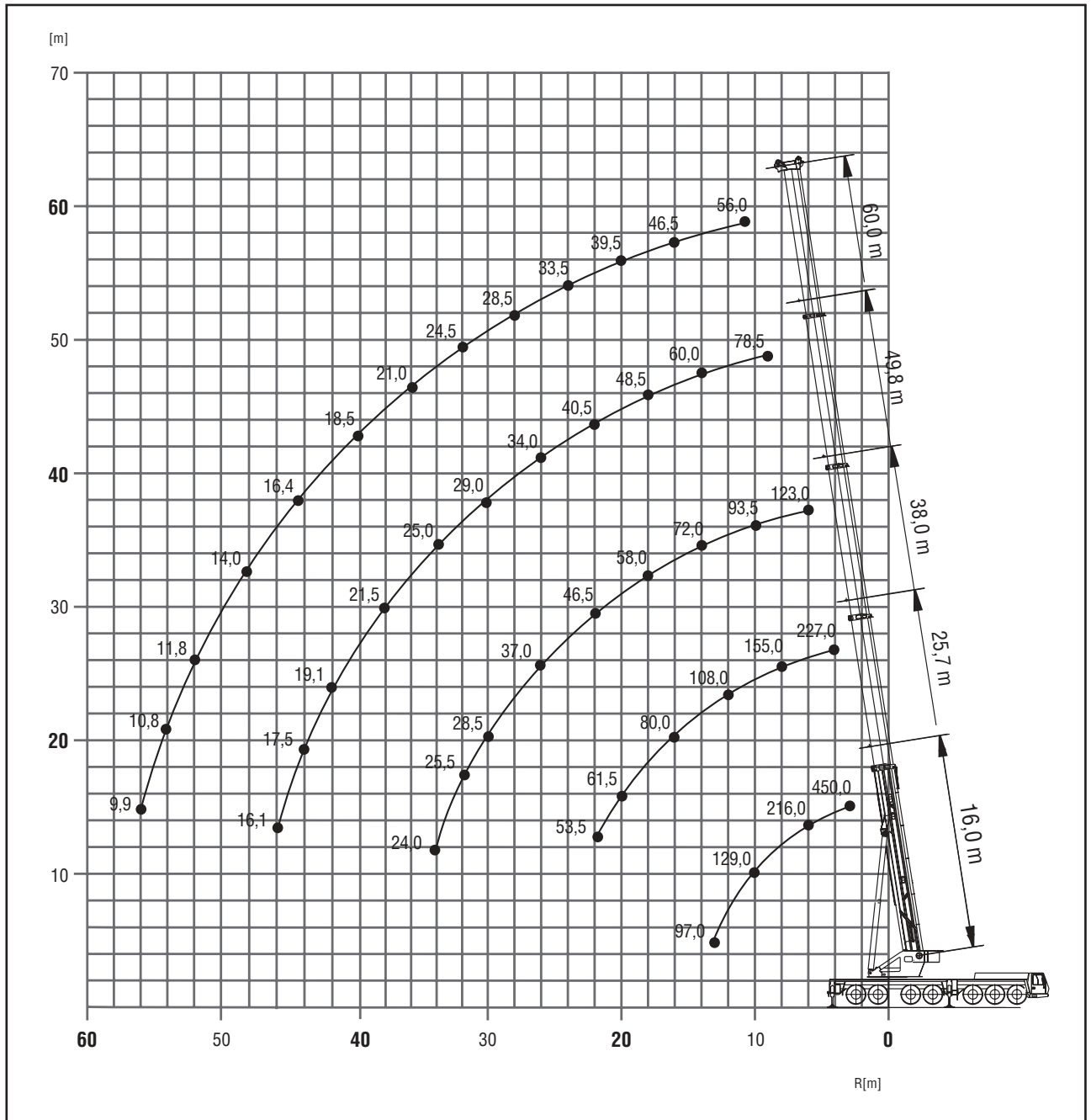

GMK7450

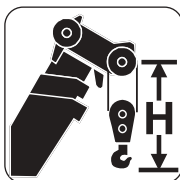

Hook block • Unterflasche • Crochet-moufle • Gancho • Gonci (t)

H (mm)

320 D	4050
250 D	3950
200 D	3650
160 D	3650
100 D/E	3300
40 D/E	3200
16 H/B	2600

Telescopic boom • Teleskopausleger • Flèche principale • Pluma telescópica • Braccio telescopico



16,0 – 60,0 m



8,9 m



360°



120 t

15



DIN/ISO

m	16,0*	16,0	20,9	25,7	30,5	35,3	38,0	40,2	45,0	49,8	54,6	60,0
2,5	**450,0/360,0											
3,0	295,0	295,0	270,0									
4,0	269,0	252,0	242,0	227,0								
5,0	250,0	218,0	218,0	207,0	195,0							
6,0	216,0	192,0	193,0	191,0	178,0	161,0	123,0					
7,0	186,0	170,0	172,0	172,0	165,0	154,0	116,0	115,0				
8,0	162,0	153,0	155,0	155,0	154,0	146,0	108,0	107,0	93,0			
9,0	144,0	139,0	140,0	140,0	139,0	138,0	101,0	99,5	89,0	78,5		
10,0	129,0	127,0	128,0	128,0	127,0	129,0	93,5	93,5	83,5	75,0	66,0	
11,0	116,0	116,0	118,0	118,0	117,0	118,0	86,5	87,0	78,5	71,5	63,5	56,0
12,0	106,0	106,0	107,0	108,0	107,0	108,0	81,5	81,0	73,0	67,5	61,0	54,5
13,0	97,0	97,0	98,5	98,5	100,0	99,5	77,0	76,5	69,5	64,0	58,5	53,0
14,0			91,0	91,0	92,5	91,5	72,0	72,5	65,5	60,0	56,0	51,0
15,0			85,0	86,0	85,5	85,0	67,0	68,0	61,5	57,0	53,5	49,0
16,0			79,0	80,0	79,5	79,0	64,0	64,5	58,0	54,5	51,0	46,5
18,0				70,0	70,0	69,0	58,0	59,5	52,5	48,5	46,5	43,0
20,0				61,5	61,5	60,5	51,5	54,5	47,5	44,5	42,0	39,5
22,0				53,5	53,5	52,0	46,5	50,0	43,0	40,5	39,0	36,0
24,0					46,5	45,5	42,0	47,0	39,5	36,5	35,5	33,5
26,0					41,5	40,0	37,0	41,5	36,0	34,0	32,5	31,0
28,0						37,0	32,5	37,0	33,5	31,5	30,0	28,5
30,0						34,5	28,5	33,5	31,5	29,0	28,0	26,0
32,0						31,0	25,5	30,0	29,5	27,0	26,0	24,5
34,0							24,0	27,0	27,5	25,0	23,5	22,5
36,0								25,0	25,0	23,0	22,5	21,0
38,0									23,0	21,5	21,0	19,6
40,0									21,0	20,0	19,8	18,5
42,0										19,1	18,3	17,4
44,0										17,5	16,7	16,4
46,0										16,1	15,3	15,3
48,0											14,0	14,0
50,0											12,8	12,8
52,0												11,8
54,0												10,8
56,0												9,9



85%

m	16,0*	16,0	20,9	25,7	30,5	35,3	38,0	40,2	45,0	49,8	54,6	60,0
2,5	**450,0/360,0											
3,0	310,0	310,0	284,0									
4,0	282,0	264,0	254,0	238,0								
5,0	262,0	229,0	229,0	217,0	205,0							
6,0	227,0	201,0	203,0	200,0	187,0	169,0	129,0					
7,0	195,0	179,0	180,0	181,0	174,0	162,0	121,0	121,0				
8,0	170,0	161,0	162,0	162,0	161,0	153,0	113,0	113,0	97,5			
9,0	151,0	146,0	147,0	147,0	146,0	145,0	106,0	105,0	93,5	82,5		
10,0	135,0	133,0	134,0	134,0	134,0	135,0	98,5	98,0	88,0	79,0	66,0	
11,0	122,0	122,0	123,0	124,0	123,0	124,0	91,0	91,5	82,5	75,0	66,0	56,0
12,0	111,0	111,0	113,0	113,0	112,0	114,0	86,0	85,0	77,0	71,0	64,5	56,0
13,0	102,0	102,0	103,0	104,0	105,0	104,0	80,5	80,5	73,0	67,0	61,5	55,5
14,0			95,5	95,5	97,0	96,0	75,5	76,0	69,0	63,0	59,0	53,5
15,0			89,5	90,0	90,0	89,0	70,5	71,5	65,0	60,0	56,0	51,0
16,0			83,0	84,0	83,5	83,0	67,0	67,5	60,5	57,0	53,5	49,0
18,0				73,5	73,5	72,5	60,5	62,5	55,5	51,0	49,0	45,0
20,0				64,5	64,5	63,5	54,5	57,5	50,0	46,5	44,0	41,5
22,0				56,5	56,0	55,0	49,0	52,5	45,0	42,5	41,0	37,5
24,0					49,5	48,0	44,0	49,5	41,5	38,5	37,5	35,0
26,0					44,0	42,5	38,5	44,0	37,5	35,5	34,0	32,5
28,0						39,0	34,0	39,5	35,0	33,0	31,5	30,0
30,0						36,5	30,0	35,5	33,0	30,5	29,5	27,5
32,0						33,0	27,0	32,0	31,0	28,5	27,0	25,5
34,0							25,0	29,0	29,5	26,5	25,0	24,0
36,0								26,5	27,0	24,5	23,5	22,0
38,0									24,5	22,5	22,0	20,5
40,0									22,5	21,0	21,0	19,4
42,0										20,0	19,3	18,3
44,0										18,6	17,6	17,2
46,0										17,1	16,1	16,1
48,0											14,8	14,8
50,0											13,5	13,5
52,0												12,4
54,0												11,4
56,0												10,4

\*\* Over rear with special equipment. Nach hinten mit Sonderausrüstung. En arrière avec équipement spécial. Por la parte trasera con equipo especial. Sull'anteriore con equipaggiamento speciale.

└ 8,76 x 6,10 m 0° over rear, nach hinten, en arrière, por la parte trasera. sull'anteriore

Lifting capacities >215 t require additional equipment. Traglasten >215 t erfordern Zusatzausrüstung. Capacités de levage >215 t demandent équipement supplémentaire. Capacidades de elevación >215 Tm requiere equipo adicional. Capacità >215 t con equipaggiamento ausiliario.

Telescopic boom • Teleskopausleger • Flèche principale • Pluma telescópica • Braccio telescopico

16



16,0 – 60,0 m



8,9 m



360°



100 t



DIN/ISO

m	16,0*	16,0	20,9	25,7	30,5	35,3	38,0	40,2	45,0	49,8	54,6	60,0
2,5	**450,0 / 360,0											
3,0	295,0	289,0	270,0									
4,0	269,0	246,0	242,0	227,0								
5,0	245,0	213,0	213,0	207,0	195,0							
6,0	205,0	187,0	188,0	188,0	178,0	161,0	123,0					
7,0	176,0	166,0	168,0	168,0	165,0	154,0	116,0	115,0				
8,0	154,0	149,0	151,0	151,0	150,0	146,0	108,0	107,0	93,0			
9,0	136,0	135,0	137,0	137,0	136,0	137,0	101,0	99,5	89,0	78,5		
10,0	122,0	122,0	124,0	124,0	123,0	124,0	93,5	93,5	83,5	75,0	66,0	
11,0	110,0	110,0	112,0	112,0	113,0	113,0	86,5	87,0	78,5	71,5	63,5	56,0
12,0	100,0	100,0	102,0	103,0	103,0	103,0	81,5	81,0	73,0	67,5	61,0	54,5
13,0	92,0	92,0	94,0	95,0	95,0	94,0	77,0	76,5	69,5	64,0	58,5	53,0
14,0			87,0	87,5	87,5	86,5	72,0	72,5	65,5	60,0	56,0	51,0
15,0			80,0	81,0	80,5	79,5	67,0	68,0	61,5	57,0	53,5	49,0
16,0			73,5	74,5	74,5	73,5	64,0	64,5	58,0	54,5	51,0	46,5
18,0				62,5	62,0	61,0	57,5	59,5	52,5	48,5	46,5	43,0
20,0				53,0	52,5	51,5	48,0	53,0	47,5	44,5	42,0	39,5
22,0				45,5	45,5	46,0	41,0	46,0	43,0	40,5	39,0	36,0
24,0					39,5	41,0	35,0	40,0	38,5	36,5	35,5	33,5
26,0					35,0	36,5	32,5	35,0	35,5	33,5	32,5	31,0
28,0						32,0	29,5	31,0	31,5	30,0	30,0	28,5
30,0						28,5	26,5	28,0	28,0	28,0	27,0	26,0
32,0						26,0	23,5	26,0	25,0	25,0	24,0	24,0
34,0							21,0	23,5	22,5	22,5	21,5	21,5
36,0								21,5	20,5	20,0	19,3	19,4
38,0									18,8	18,1	17,3	17,4
40,0									17,1	16,4	15,6	15,7
42,0										14,9	14,1	14,1
44,0										13,5	12,7	12,8
46,0										12,3	11,5	11,5
48,0											10,4	10,4
50,0											9,4	9,4
52,0												8,5
54,0												7,6
56,0												6,9



Telescopic boom • Teleskopausleger • Flèche principale • Pluma telescópica • Braccio telescopico



16,0 – 60,0 m



8,9 m



360°



80 t

17



DIN/ISO

m	16,0*	16,0	20,9	25,7	30,5	35,3	38,0	40,2	45,0	49,8	54,6	60,0
2,5	** 450,0 / 360,0											
3,0	295,0	283,0	270,0									
4,0	269,0	240,0	240,0	227,0								
5,0	232,0	207,0	209,0	207,0	195,0							
6,0	194,0	182,0	184,0	184,0	178,0	161,0	123,0					
7,0	167,0	162,0	163,0	163,0	163,0	154,0	116,0	115,0				
8,0	146,0	145,0	147,0	147,0	146,0	146,0	108,0	107,0	93,0			
9,0	129,0	129,0	130,0	131,0	131,0	131,0	101,0	99,5	89,0	78,5		
10,0	115,0	115,0	117,0	117,0	118,0	118,0	93,5	93,5	83,5	75,0	66,0	
11,0	104,0	104,0	106,0	107,0	107,0	105,0	86,5	87,0	78,5	71,5	63,5	56,0
12,0	93,5	93,5	96,5	97,5	97,0	94,0	81,5	81,0	73,0	67,5	61,0	54,5
13,0	83,5	82,5	87,0	88,5	88,0	84,5	77,0	76,5	69,5	64,0	58,5	53,0
14,0			77,0	78,5	78,0	76,5	70,5	72,5	65,5	60,0	56,0	51,0
15,0			69,0	70,0	70,0	68,5	64,0	68,0	61,5	57,0	53,5	49,0
16,0			62,0	63,0	63,0	62,0	58,0	63,5	58,0	54,5	51,0	46,5
18,0				52,0	52,0	54,0	47,0	52,5	49,5	48,5	46,5	43,0
20,0				44,5	43,5	45,0	42,0	44,0	44,5	42,0	42,0	39,5
22,0				37,5	39,0	38,5	36,0	37,5	38,0	37,5	36,5	36,0
24,0					33,5	33,0	31,0	33,5	32,5	32,5	31,5	31,5
26,0					29,5	29,0	26,5	29,5	29,0	28,0	27,5	27,5
28,0						26,0	24,5	26,0	25,5	24,5	24,0	24,0
30,0						23,0	23,0	23,0	22,5	21,5	21,0	21,0
32,0						20,5	21,0	20,5	19,8	19,1	18,4	18,4
34,0							18,7	18,2	17,7	16,9	16,2	16,3
36,0								16,4	15,8	15,0	14,3	14,4
38,0									14,1	13,4	12,6	12,7
40,0									12,7	12,0	11,2	11,2
42,0										10,7	9,9	9,9
44,0										9,5	8,7	8,8
46,0										8,6	7,7	7,7
48,0											6,8	6,8
50,0											5,9	5,9
52,0												5,2
54,0												4,5
56,0												3,9

Telescopic boom • Teleskopausleger • Flèche principale • Pluma telescópica • Braccio telescopico

18



16,0 – 60,0 m



8,9 m



360°



60 t



DIN/ISO

m	16,0	20,9	25,7	30,5	35,3	38,0	40,2	45,0	49,8	54,6	60,0
3,0	276,0	270,0									
4,0	234,0	234,0	227,0								
5,0	202,0	203,0	204,0	195,0							
6,0	177,0	179,0	179,0	178,0	161,0	123,0					
7,0	157,0	159,0	159,0	158,0	154,0	116,0	115,0				
8,0	137,0	139,0	139,0	141,0	133,0	108,0	107,0	93,0			
9,0	120,0	122,0	125,0	121,0	113,0	101,0	99,5	89,0	78,5		
10,0	103,0	108,0	110,0	105,0	98,0	90,5	92,5	83,5	75,0	66,0	
11,0	87,5	92,0	94,0	92,0	86,0	78,5	83,5	77,5	71,5	63,5	56,0
12,0	75,5	79,5	81,5	81,0	75,5	68,5	74,5	68,5	66,5	61,0	54,5
13,0	65,5	70,0	71,5	71,0	69,5	62,0	66,5	62,5	59,5	58,5	53,0
14,0		61,5	63,5	63,0	64,0	58,0	60,0	58,5	54,5	53,0	51,0
15,0		55,0	56,0	56,0	58,0	53,5	54,0	53,0	51,0	48,5	46,5
16,0		48,5	51,0	52,0	51,5	48,5	49,5	48,5	46,5	44,0	42,5
18,0			41,0	42,5	42,0	39,5	42,5	41,5	39,0	37,0	36,0
20,0			34,0	35,5	35,5	34,5	35,5	35,0	33,5	31,5	31,0
22,0			28,5	30,0	30,0	30,5	30,0	29,5	28,5	27,5	26,5
24,0				25,5	25,5	26,0	25,5	25,0	24,0	23,5	23,0
26,0				22,0	22,0	22,5	22,0	21,5	20,5	20,0	20,0
28,0					19,3	19,6	19,1	18,6	17,8	17,1	17,2
30,0					16,9	17,1	16,7	16,2	15,4	14,7	14,8
32,0					14,8	15,1	14,6	14,1	13,4	12,6	12,7
34,0						13,3	12,9	12,3	11,6	10,8	10,9
36,0							11,4	10,8	10,0	9,3	9,4
38,0								9,4	8,7	7,9	8,0
40,0								8,3	7,5	6,7	6,8
42,0									6,5	5,7	5,7
44,0									5,6	4,7	4,8
46,0									4,8	3,9	3,9
48,0										3,1	3,2
50,0										2,5	2,5
52,0											1,9



16,0 – 60,0 m



360°



0 t



DIN/ISO

m	16,0	20,9	25,7	27,7	30,5	35,3	48,9	54,4	60,0
3,0	255,0	254,0							
4,0	216,0	208,0	174,0	130,0					
5,0	156,0	131,0	109,0	106,0	95,0				
6,0	93,0	84,0	75,5	74,0	68,0	60,5	57,5		
7,0	62,5	59,5	56,0	55,0	51,5	47,0	45,0	42,0	
8,0	45,0	45,0	43,0	42,5	40,5	37,5	36,0	34,0	30,0
9,0	34,0	35,0	34,5	34,0	33,0	30,5	29,5	28,0	24,5
10,0	26,0	27,5	28,0	28,0	27,0	25,5	24,5	23,0	20,5
11,0	20,5	22,5	23,0	23,0	22,5	21,0	21,0	19,3	17,1
12,0	15,3	18,1	19,0	19,2	18,9	17,9	17,6	16,3	14,4
13,0	11,3	14,8	15,9	16,1	16,0	15,1	14,9	13,8	12,0
14,0		12,0	13,2	13,5	13,5	12,8	12,7	11,7	10,1
15,0		9,6	11,1	11,3	11,4	10,9	10,8	9,8	8,4
16,0		7,5	9,2	9,5	9,7	9,2	9,2	8,3	6,9
18,0			6,2	6,5	6,8	6,5	6,5	5,7	4,5
20,0			3,8	4,2	4,6	4,3	4,4	3,7	2,5
22,0			1,9	2,3	2,9	2,6	2,8	2,0	

Lifting capacities >210 t require additional equipment. Traglasten >210 t erfordern Zusatzausrüstung. Capacités de levage >210t demandent équipement supplémentaire. Capacidades de elevación >210 Tm requiere equipo adicional. Capacità >210 t con equipaggiamento ausiliario.

GMK7450

**Mega-Wing-Lift**

Working range • Arbeitsbereiche • Diagramme de levage • Gama de trabajo • Area di lavoro

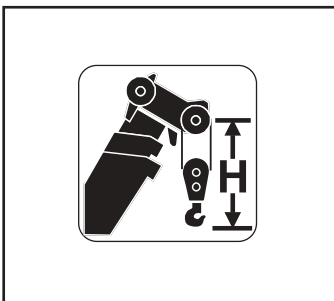
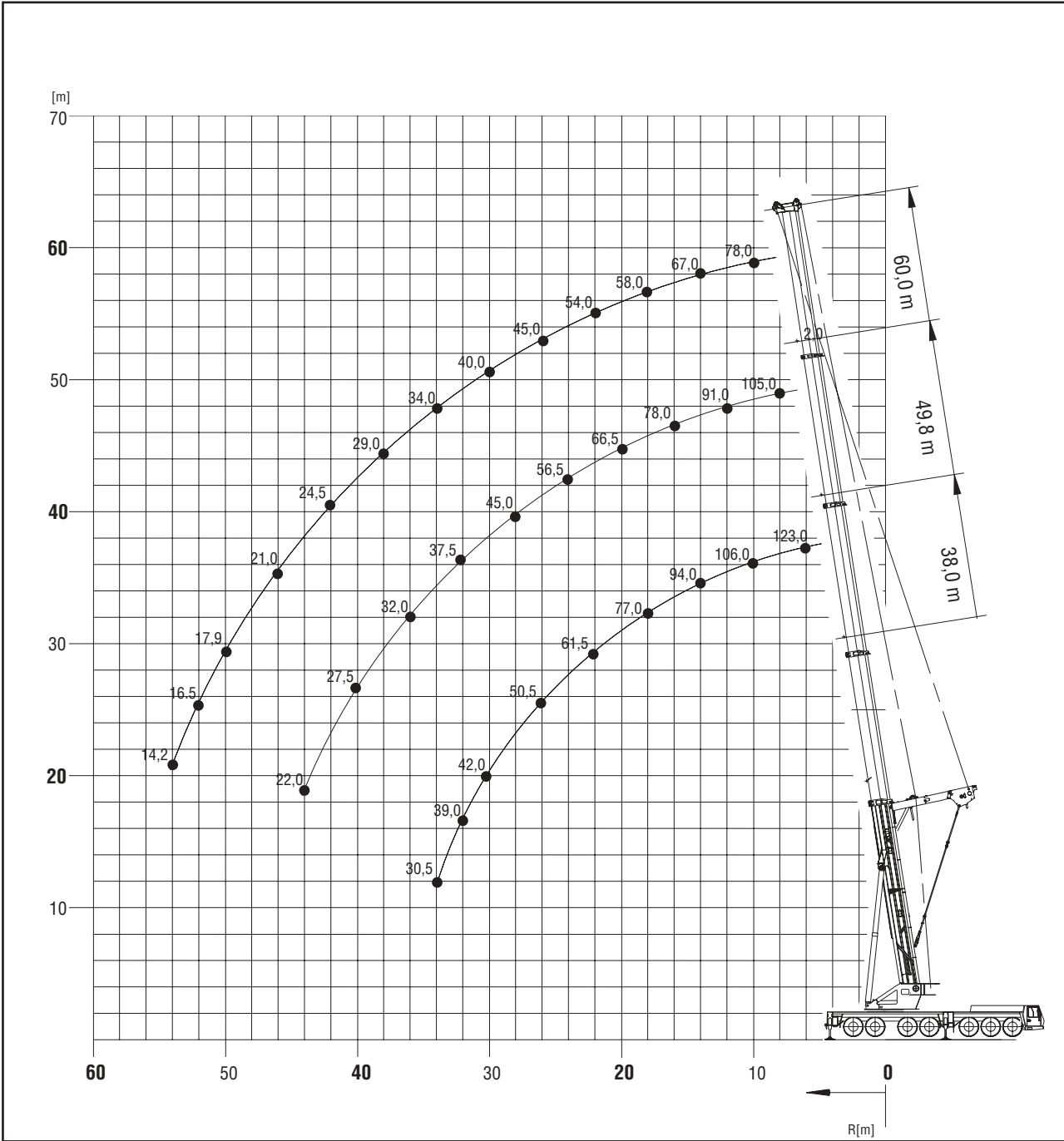

Hook block • Unterflasche • Crochet-moufle • Gancho • Gonci (t)	H (mm)
320 D	4050
250 D	3950
200 D	3650
160 D	3650
100 D/E	3300
40 D/E	3200
16 H/B	2600

20

**Mega-Wing-Lift**  
 Telescopic boom • Teleskopausleger • Flèche principale • Pluma telescópica • Braccio telescopico



35,3 – 60,0 m



8,9 m



360°



160 t



DIN/ISO

m	35,3	38,0	40,2	45,0	49,8	54,6	60,0
5,0	166,0						
6,0	160,0	123,0	150,0				
7,0	152,0	118,0	145,0	140,0			
8,0	144,0	114,0	137,0	131,0	105,0		
9,0	136,0	110,0	128,0	123,0	101,0	97,5	
10,0	129,0	106,0	121,0	115,0	98,0	93,5	78,0
11,0	121,0	103,0	115,0	109,0	94,5	89,5	75,0
12,0	111,0	100,0	109,0	104,0	91,0	85,0	72,0
13,0	105,0	97,0	103,0	99,0	87,5	82,0	69,5
14,0	98,5	94,0	97,5	94,5	84,0	78,5	67,0
15,0	92,0	90,0	91,0	89,0	81,0	75,0	64,5
16,0	86,5	84,0	85,0	83,0	78,0	72,0	62,5
18,0	76,5	77,0	76,5	74,5	71,5	67,0	58,0
20,0	68,5	69,0	68,5	68,0	66,5	62,0	54,5
22,0	61,0	61,5	61,5	61,0	60,5	57,5	51,0
24,0	55,0	55,5	55,0	55,0	54,5	53,5	48,0
26,0	50,0	50,5	50,0	49,5	49,5	48,5	45,0
28,0	45,5	46,0	45,5	45,5	45,0	44,0	42,5
30,0	41,5	42,0	42,0	41,5	41,0	40,5	40,0
32,0		39,0	38,5	38,0	37,5	37,0	37,0
34,0		30,5	35,5	35,0	34,5	34,0	34,0
36,0			28,0	32,5	32,0	31,5	31,5
38,0				30,5	30,0	29,0	29,0
40,0				25,0	27,5	26,5	26,5
42,0					25,5	24,5	24,5
44,0					22,0	22,5	22,5
46,0						21,0	21,0
48,0						19,1	19,3
50,0						14,4	17,9
52,0							16,5
54,0							14,2



35,3 – 60,0 m



360°



140 t



DIN/ISO

m	35,3	38,0	40,2	45,0	49,8	54,6	60,0
5,0	166,0						
6,0	160,0	123,0	150,0				
7,0	152,0	118,0	145,0	140,0			
8,0	144,0	114,0	137,0	131,0	105,0		
9,0	136,0	110,0	128,0	123,0	101,0	97,5	
10,0	128,0	106,0	121,0	115,0	98,0	93,5	78,0
11,0	118,0	103,0	115,0	109,0	94,5	89,5	75,0
12,0	109,0	100,0	108,0	104,0	91,0	85,0	72,0
13,0	103,0	97,0	102,0	99,0	88,0	82,0	69,5
14,0	96,0	94,0	95,0	93,0	85,5	78,5	67,0
15,0	90,0	87,5	88,5	86,5	82,5	75,0	64,5
16,0	84,0	84,0	84,0	81,0	80,0	72,0	62,5
18,0	73,5	74,0	73,5	73,0	71,5	67,0	58,0
20,0	65,0	65,5	65,0	65,0	64,5	62,0	54,5
22,0	58,0	58,5	58,5	58,0	57,5	57,0	51,0
24,0	52,5	53,0	52,5	52,0	51,5	51,0	48,0
26,0	47,5	48,0	47,5	47,0	46,5	46,0	45,0
28,0	43,5	43,5	43,5	43,0	42,5	41,5	42,0
30,0	39,5	40,0	39,5	39,0	38,5	37,5	38,0
32,0		36,0	35,5	35,0	34,5	34,0	34,0
34,0		30,5	32,5	32,0	31,5	30,5	31,0
36,0			28,0	29,0	28,5	27,5	28,0
38,0				26,5	26,0	25,0	25,5
40,0				24,5	24,0	23,0	23,0
42,0					22,0	21,0	21,0
44,0					20,0	19,2	19,4
46,0						17,6	17,7
48,0						16,2	16,3
50,0						14,4	15,0
52,0							13,7
54,0							12,7

GMK7450

**Mega-Wing-Lift**

Telescopic boom • Teleskopausleger • Flèche principale • Pluma telescópica • Braccio telescopico



35,3 – 60,0 m



8,9 m



360°



120 t



DIN/ISO

m	35,3	38,0	40,2	45,0	49,8	54,6	60,0
5,0	166,0						
6,0	160,0	123,0	150,0				
7,0	152,0	118,0	145,0	140,0			
8,0	144,0	114,0	137,0	131,0	105,0		
9,0	136,0	110,0	128,0	123,0	101,0	97,5	
10,0	125,0	106,0	121,0	115,0	98,0	93,5	78,0
11,0	115,0	103,0	114,0	109,0	94,5	89,5	75,0
12,0	108,0	100,0	107,0	104,0	91,0	85,0	72,0
13,0	100,0	97,0	99,0	97,0	88,0	82,0	69,5
14,0	92,5	90,0	91,5	89,5	85,5	78,5	67,0
15,0	85,5	86,0	85,5	85,0	82,5	75,0	64,5
16,0	79,5	80,0	79,5	79,0	78,0	72,0	62,5
18,0	69,5	70,0	69,5	69,5	69,0	67,0	58,0
20,0	61,5	62,0	61,5	61,0	61,0	60,0	54,5
22,0	54,5	55,0	54,5	54,0	53,5	53,0	51,0
24,0	48,0	48,5	48,0	48,0	47,0	46,5	46,5
26,0	42,5	43,0	42,5	42,0	41,5	41,0	41,0
28,0	38,0	38,5	38,0	37,5	37,0	36,0	36,5
30,0	34,0	34,5	34,0	33,5	33,0	32,0	32,5
32,0		31,0	30,5	30,0	29,5	29,0	29,0
34,0		28,0	27,5	27,0	26,5	26,0	26,0
36,0			25,0	24,5	24,0	23,5	23,5
38,0				22,5	22,0	21,0	21,0
40,0				20,5	19,8	19,0	19,2
42,0					18,1	17,2	17,4
44,0					16,5	15,6	15,8
46,0						14,2	14,3
48,0						12,9	13,0
50,0						11,8	11,8
52,0							10,7
54,0							9,7



35,3 – 60,0 m



360°



100 t



DIN/ISO

m	35,3	38,0	40,2	45,0	49,8	54,6	60,0
5,0	166,0						
6,0	160,0	123,0	150,0				
7,0	152,0	118,0	145,0	140,0			
8,0	144,0	114,0	137,0	131,0	105,0		
9,0	134,0	110,0	128,0	123,0	101,0	97,5	
10,0	122,0	106,0	121,0	115,0	98,0	93,5	78,0
11,0	111,0	103,0	112,0	109,0	94,5	89,5	75,0
12,0	103,0	100,0	102,0	100,0	91,0	85,0	72,0
13,0	94,5	92,5	94,0	93,5	88,0	82,0	69,5
14,0	87,5	87,5	87,5	87,0	84,0	78,5	67,0
15,0	81,0	81,5	81,0	80,5	78,5	75,0	64,5
16,0	75,0	75,5	75,0	74,5	72,5	69,5	62,5
18,0	64,5	65,0	64,5	64,0	62,5	60,0	58,0
20,0	55,0	55,5	55,0	54,5	54,0	52,5	51,0
22,0	47,0	47,5	47,5	47,0	46,0	45,5	45,0
24,0	41,0	41,5	41,0	40,5	40,0	39,5	39,5
26,0	36,0	36,5	36,0	35,5	35,0	34,5	34,5
28,0	32,0	32,5	32,0	31,5	31,0	30,0	30,5
30,0	28,5	29,0	28,5	28,0	27,5	26,5	27,0
32,0		26,0	25,5	25,0	24,5	23,5	24,0
34,0		23,0	23,0	22,5	21,5	21,0	21,0
36,0			20,5	20,0	19,4	18,6	18,8
38,0				18,0	17,4	16,5	16,7
40,0				16,2	15,6	14,7	14,9
42,0					14,0	13,1	13,3
44,0					12,6	11,7	11,9
46,0						10,5	10,6
48,0						9,3	9,4
50,0						8,3	8,4
52,0							7,4
54,0							6,6

22



16,0 – 54,6 m



3°, 25°  
12 – 70 m



8,9 m



360°

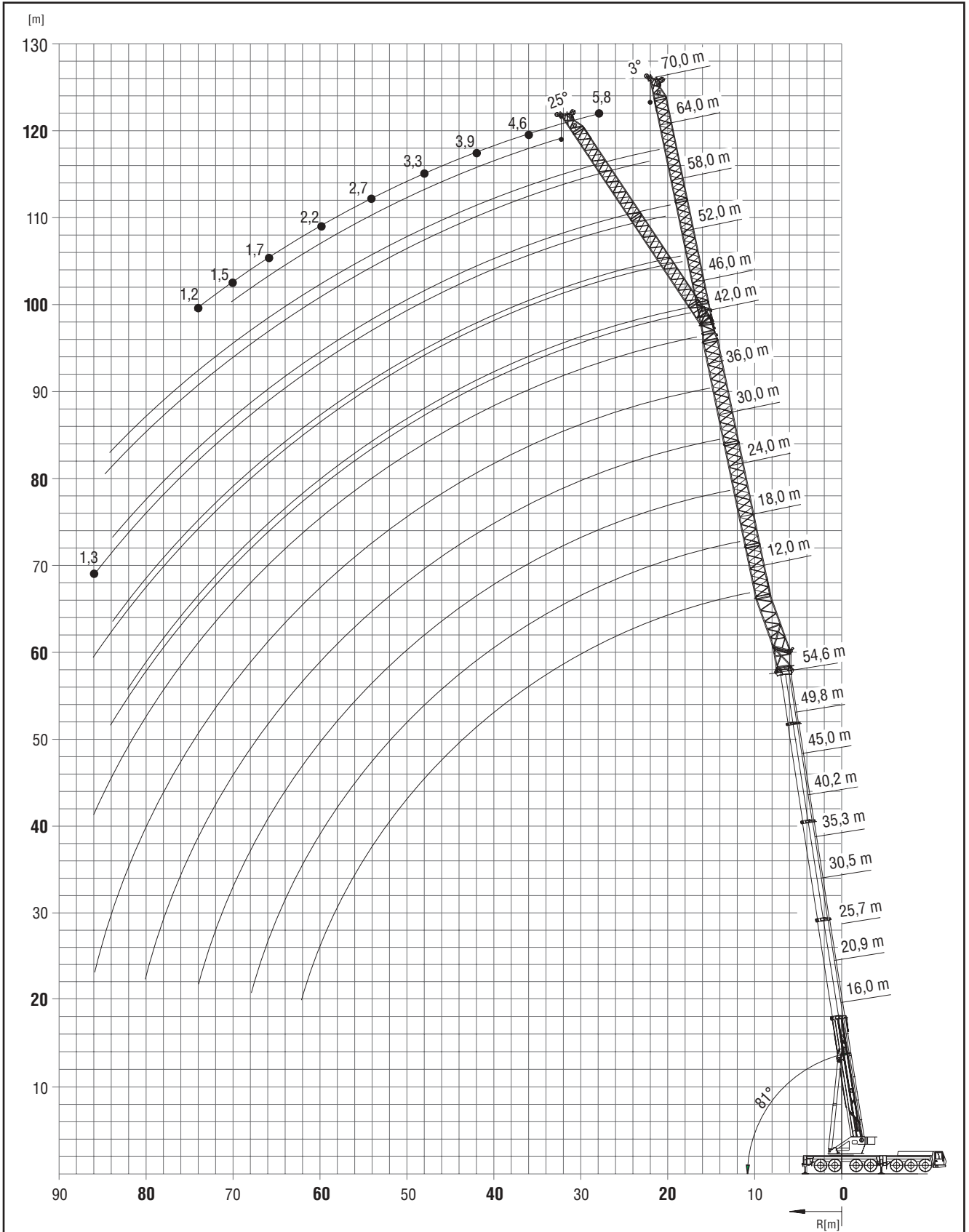

GMK7450

Lattice extension • Auslegerverlängerung • Extension treillis • Plumín fijo • Jib



49,8 m – 54,6



3°, 25°  
12 – 70 m



8,9 m



360°



120 t



DIN/ISO

m		49,8											
m	12	18	24	30	36	42	46	52	58	64	70		
	3°	3°	3°	3°	3°	3°	3° 25°	3° 25°	3° 25°	3° 25°	3° 25°	3° 25°	3° 25°
13,0	46,0												
14,0	45,0	38,5											
15,0	43,5	37,5											
16,0	42,5	36,5	29,0										
18,0	39,5	35,0	27,5	22,0									
20,0	36,5	33,0	26,0	21,0	18,6								
22,0	33,5	30,5	24,5	20,0	17,7	14,9	12,4						
24,0	30,5	28,0	23,5	19,0	16,8	14,2	11,8	11,1	10,2				
26,0	28,5	26,0	22,0	18,1	16,0	13,5	11,2	10,6	9,7	8,5			
28,0	26,0	24,0	21,0	17,2	15,3	12,7	10,6	10,0	9,2	8,2	8,1	6,8	5,8
30,0	23,5	22,5	20,5	16,5	14,6	11,8	10,0	9,5	8,7	7,8	7,6	6,5	5,5
32,0	22,5	21,0	19,4	15,8	13,9	11,1	9,5	9,0	8,3	7,4	7,2	6,2	5,2
34,0	21,0	19,8	18,4	15,1	13,3	10,7	9,0	8,6	7,8	7,0	6,8	5,9	5,8
36,0	19,3	18,4	17,4	14,4	12,7	10,2	8,6	8,2	7,4	6,7	6,5	5,6	4,6
38,0	17,8	17,2	16,4	13,7	12,0	9,7	8,2	7,8	7,1	6,4	6,1	5,3	4,3
40,0	16,5	16,2	15,4	13,0	11,3	9,4	7,8	7,4	6,7	6,0	5,8	5,0	4,1
42,0	15,4	15,1	14,4	12,3	10,6	9,0	7,4	7,1	6,3	5,8	5,5	4,8	4,1
44,0	14,2	14,1	13,4	11,6	10,2	8,6	7,1	6,8	6,0	5,5	5,2	4,5	3,6
46,0	13,1	13,1	12,4	11,1	9,9	8,3	6,8	6,5	5,8	5,2	4,9	4,3	3,4
48,0	12,0	12,2	11,4	10,6	9,5	8,0	6,5	6,2	5,5	5,0	4,7	4,1	3,2
50,0	11,1	11,3	10,6	10,1	9,1	7,7	6,2	5,9	5,2	4,8	4,4	3,9	3,0
52,0	10,1	10,4	10,0	9,5	8,8	7,4	5,9	5,7	4,9	4,5	4,2	3,7	2,9
54,0	9,1	9,6	9,5	9,0	8,4	7,1	5,7	5,5	4,7	4,3	4,0	3,5	2,7
56,0	8,1	8,8	8,9	8,5	8,1	6,8	5,4	5,2	4,5	4,1	3,8	3,3	2,5
58,0	7,3	8,0	8,3	8,0	7,7	6,6	5,2	5,0	4,3	4,0	3,6	3,1	2,4
60,0		7,1	7,7	7,5	7,3	6,4	5,0	4,8	4,1	3,8	3,4	3,0	2,2
62,0		6,4	7,1	7,1	6,9	6,2	4,8	4,6	3,9	3,6	3,2	2,8	2,1
66,0			5,7	6,1	6,1	5,7	4,4	4,3	3,6	3,3	2,9	2,6	2,0
70,0			4,4	4,8	5,2	5,0	3,9	3,8	3,2	3,0	2,6	2,3	1,6
74,0				3,6	4,0	4,1	3,2	3,4	2,9	2,6	2,4	2,1	1,4
78,0					2,9	3,1	2,2	2,3	2,5	2,7	2,1	1,9	1,2
82,0						2,1	1,2	1,3	1,5	2,5	1,8	1,6	1,0
86,0							1,2		1,9		1,3		

m		54,6											
m	12	18	24	30	36	42	46	52	58	64	70		
	3°	3°	3°	3°	3°	3°	3° 25°	3° 25°	3° 25°	3° 25°	3° 25°	3° 25°	3° 25°
13,0													
14,0	38,5												
15,0	37,5	34,0											
16,0	36,5	33,0											
18,0	34,5	31,5	26,0										
20,0	33,0	29,0	25,0	21,0									
22,0	30,5	27,5	24,0	20,0	17,0								
24,0	28,5	25,5	22,5	19,3	16,3	13,7	11,3	10,7					
26,0	26,0	23,5	21,5	18,5	15,6	12,8	10,8	10,2	9,3				
28,0	24,0	22,0	20,0	17,7	15,0	11,9	10,3	9,8	8,9	7,6	7,6		
30,0	22,5	21,0	19,0	16,9	14,3	11,5	9,8	9,3	8,4	7,3	7,3	6,1	5,0
32,0	21,0	19,4	18,0	16,1	13,6	11,0	9,4	8,9	8,0	7,3	6,9	6,0	5,8
34,0	19,7	18,3	16,9	15,3	12,9	10,5	8,9	8,5	7,7	6,9	6,7	5,7	4,6
36,0	18,3	17,2	16,0	14,6	12,1	10,1	8,5	8,1	7,3	6,6	6,3	5,5	4,3
38,0	17,2	16,1	15,2	13,8	11,5	9,7	8,2	7,8	7,0	6,3	6,0	5,2	4,1
40,0	16,1	15,1	14,3	13,1	11,1	9,3	7,8	7,4	6,6	6,0	5,7	4,9	3,9
42,0	15,0	14,1	13,5	12,3	10,6	9,0	7,4	7,1	6,3	5,7	5,5	4,7	3,8
44,0	13,9	13,1	12,7	11,5	10,1	8,7	7,1	6,8	6,0	5,5	5,2	4,5	3,6
46,0	13,0	12,1	12,0	10,8	9,7	8,3	6,8	6,5	5,8	5,2	4,9	4,3	3,4
48,0	12,1	11,0	11,2	10,0	9,2	8,0	6,5	6,3	5,5	5,0	4,7	4,1	3,2
50,0	11,2	10,4	10,4	9,4	8,7	7,7	6,2	6,0	5,3	4,8	4,5	3,9	3,0
52,0	10,2	9,8	9,6	8,9	8,3	7,4	6,0	5,8	5,0	4,6	4,2	3,7	2,9
54,0	9,3	9,2	9,0	8,5	7,9	7,0	5,7	5,5	4,8	4,4	4,0	3,5	2,7
56,0	8,7	8,6	8,5	8,0	7,5	6,7	5,5	5,3	4,6	4,2	3,9	3,4	2,5
58,0	7,8	8,0	8,0	7,5	7,1	6,4	5,2	5,1	4,4	4,0	3,7	3,2	2,4
60,0	7,0	7,4	7,5	7,1	6,7	6,1	4,9	4,9	4,2	3,9	3,5	3,0	2,2
62,0	6,3	6,7	7,0	6,7	6,4	5,8	4,7	4,6	4,0	3,7	3,3	2,9	2,1
66,0		5,3	5,9	5,9	5,7	5,2	4,1	4,1	3,6	3,4	3,0	2,6	1,9
70,0			4,6	4,9	5,0	4,6	3,6	3,6	3,2	3,0	2,7	2,4	1,7
74,0			3,5	3,8	4,1	4,0	3,1	3,2	2,7	2,7	2,4	2,2	1,5
78,0				2,7	3,0	3,1	2,2	2,4	2,3	2,4	2,0	1,9	1,3
82,0					2,1	2,1	1,2	1,4	1,5	1,9	1,7	1,7	1,1
86,0						1,2					1,4		

**Mega-Wing-Lift**

Lattice extension • Auslegerverlängerung • Extension treillis • Plumín fijo • Jib

24



49,8 – 54,6 m



3°  
12 – 24 m



8,9 m



360°



160 t



DIN/ISO

m		49,8		54,6		
m	12	18	24	12	18	24
3°	3°	3°	3°	3°	3°	3°
12,0	52,5					
13,0	50,0	40,0		46,5		
14,0	47,5	38,5	31,0	44,5	37,0	
15,0	46,0	37,0	30,0	44,3	36,0	
16,0	44,0	36,0	29,0	41,0	34,5	28,5
18,0	41,0	33,0	27,5	38,0	32,0	27,0
20,0	38,0	31,0	26,0	35,5	29,5	25,0
22,0	36,0	29,0	24,5	33,0	27,5	23,0
24,0	33,5	27,0	22,5	31,0	25,0	22,0
26,0	31,5	25,5	21,5	29,0	23,5	20,5
28,0	30,0	23,5	20,0	27,5	22,5	19,3
30,0	28,5	22,5	19,0	26,0	21,0	18,3
32,0	27,0	21,5	17,9	24,5	19,8	17,3
34,0	25,5	20,5	17,1	23,0	19,0	16,4
36,0	24,5	19,2	16,3	22,0	18,1	15,5
38,0	23,0	18,3	15,5	20,5	17,2	14,6
40,0	22,0	17,6	14,7	19,9	16,4	13,8
42,0	21,0	16,9	14,0	19,1	15,6	13,0
44,0	20,5	16,1	13,3	18,3	14,8	12,1
46,0	19,5	15,4	12,6	17,5	14,0	11,6
48,0	17,9	14,9	12,0	16,9	13,3	11,2
50,0	16,4	14,3	11,3	16,3	12,5	10,7
52,0	15,0	13,8	10,8	15,5	12,0	10,3
54,0	13,7	13,3	10,4	14,2	11,6	9,8
56,0	12,2	12,8	10,0	13,0	11,2	9,5
58,0		12,2	9,7	11,9	10,8	9,2
60,0		11,2	9,3	10,9	10,5	8,8
62,0		9,7			10,2	
66,0					8,8	



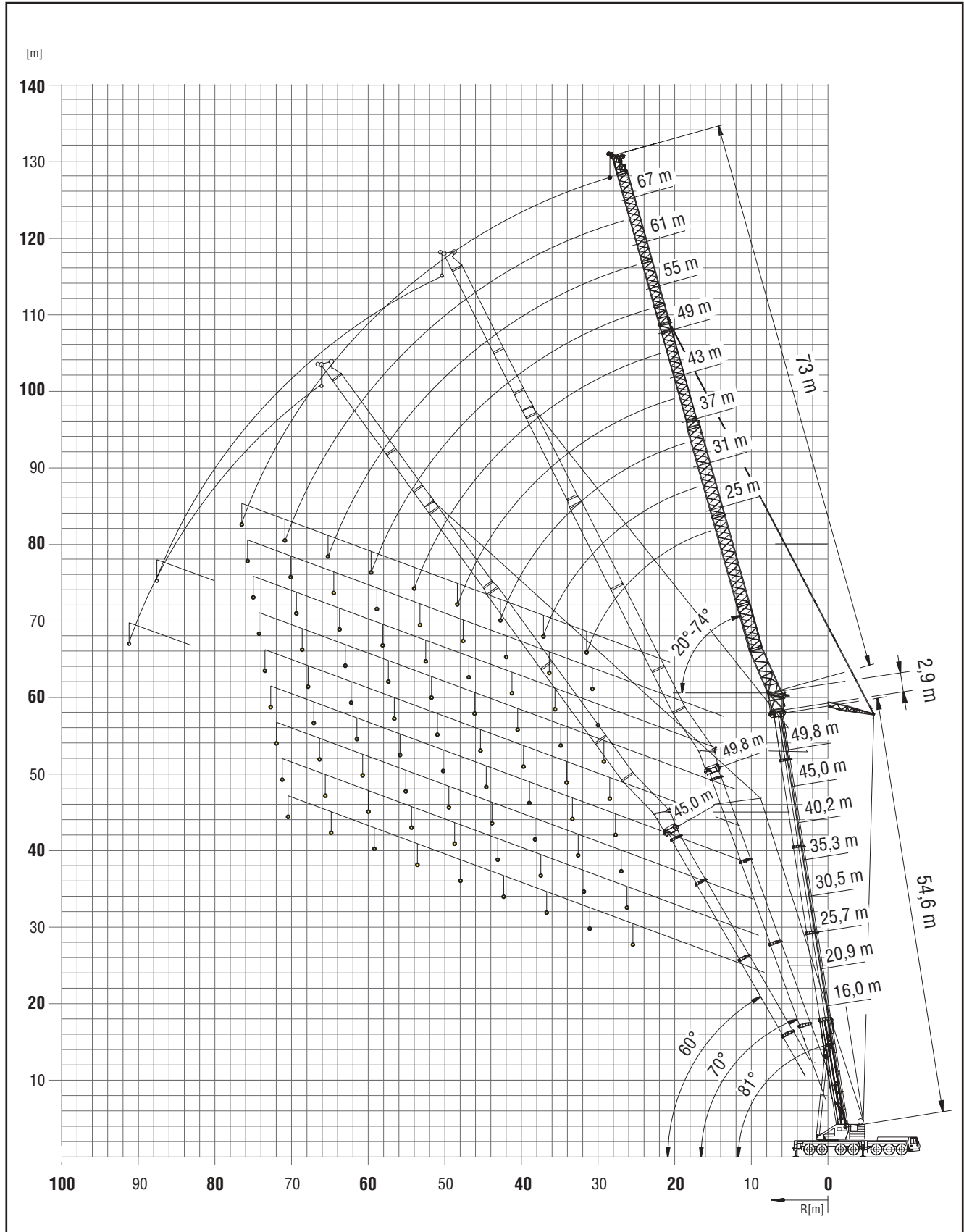
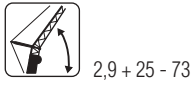

Luffing jib • Wippspitzenausleger • Volée variable • Plumín de angulación variable • Jib a volata variable

26



81°  
16,0 + 2,9 m



25 - 73  
0°/22° \*



8,9 m



360°



120 t



DIN/ISO

m		16,0 + 2,9											
m	25	31	37	43	49	55		61		67		73	
	0°	0°	0°	0°	0°	0°	22°	0°	22°	0°	22°	0°	22°
11,0	80,0												
12,0	77,5	65,5											
13,0	74,5	64,0											
14,0	72,0	63,0	52,5										
15,0	69,0	62,0	51,5	42,0									
16,0	66,0	61,0	51,0	41,5									
18,0	61,0	58,5	49,5	40,5	33,5								
20,0	57,5	56,5	48,0	39,5	32,5	26,0	26,0	19,7					
22,0	50,5	54,5	46,5	38,5	31,5	25,0	25,0	19,1		15,0			
24,0	41,0	50,0	45,5	38,0	30,5	24,0	24,5	18,4	18,5	14,5	10,7	10,7	
26,0	31,0	43,5	43,5	37,0	29,5	23,5	23,5	17,7	17,9	13,9	10,3	10,3	
28,0		37,0	42,0	36,0	28,5	22,5	22,5	17,2	17,3	13,4	12,6	9,9	
30,0		31,0	37,5	34,5	28,0	21,5	21,5	16,6	16,7	12,9	12,2	9,5	
32,0		24,0	33,0	33,5	27,0	21,0	21,0	16,0	16,2	12,3	11,8	9,1	8,0
34,0			28,5	32,0	26,0	20,0	20,0	15,4	15,6	11,7	11,5	8,7	7,8
36,0			24,5	29,0	25,5	19,5	19,5	14,9	15,1	11,1	10,8	8,4	7,5
38,0			19,4	26,0	24,5	18,9	18,9	14,4	14,6	10,5	10,2	8,0	7,3
40,0				22,5	24,0	18,3	18,3	14,0	14,1	10,2	9,6	7,7	7,1
42,0				19,4	22,0	17,8	17,8	13,5	13,6	9,8	9,4	7,4	6,9
44,0					19,8	17,2	17,3	12,9	13,2	9,5	9,2	7,0	6,7
46,0					17,7	16,7	16,8	12,4	12,7	9,1	9,0	6,8	6,6
48,0					15,6	16,2	16,3	11,9	12,3	8,8	8,8	6,5	6,4
50,0						15,3	15,8	11,3	11,8	8,5	8,5	6,2	6,2
52,0						14,4	15,0	11,0	11,3	8,2	8,3	6,0	6,1
54,0						12,8		10,7	10,9	7,9	8,0	5,7	5,9
56,0								10,4	10,4	7,7	7,8	5,5	5,6
58,0								10,0		7,4	7,5	5,3	5,4
60,0									9,7	7,1	7,2	5,1	5,2
62,0										6,9	7,0	4,8	5,0
64,0										6,7	6,7	4,6	4,8
66,0										6,4	4,4	4,4	
68,0											4,2	4,2	
70,0											4,1	4,1	
72,0											3,9	3,9	

\* Jib offset 22° after suspension point. 22° Abwinkelung oberhalb der Spitzenabspannung. Deport de flechette 22° après le point de suspension. Plumín articulado angular 22° a partir 55m. Inclinazione del jib a 22° dopo il punto di cerniera.

Luffing jib • Wippspitzenausleger • Volée variable • Plumín de angulación variable • Jib a volata variable



81°  
25,7 + 2,9 m



25 - 73  
0°/22° \*



8,9 m



360°



120 t









DIN/ISO

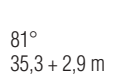





m		25,7 + 2,9											
m	25	31	37	43	49	55		61		67		73	
	0°	0°	0°	0°	0°	0°	22°	0°	22°	0°	22°	0°	22°
13,0	71,5												
14,0	69,0	57,0											
15,0	66,5	57,0											
16,0	64,0	56,0	45,5										
18,0	59,0	55,0	45,0	36,0									
20,0	55,0	53,5	44,5	36,0	29,0								
22,0	52,0	52,0	43,5	36,0	28,5	22,5		17,6					
24,0	49,0	50,5	42,5	35,0	28,0	21,5	22,0	17,1		13,5			
26,0	46,5	49,5	41,5	34,5	27,0	21,0	21,0	16,6	16,8	13,0			9,8
28,0	35,0	47,0	41,0	34,0	26,5	20,5	20,5	16,1	16,3	12,4			9,4
30,0		42,0	40,0	33,0	26,0	20,0	20,0	15,6	15,8	11,9	12,2		9,1
32,0		36,0	39,0	32,5	25,0	19,6	19,6	15,2	15,4	11,3	11,5		8,8
34,0		27,5	36,0	32,0	24,5	19,0	19,1	14,8	14,9	11,0	10,8	8,4	7,8
36,0			32,5	31,5	24,0	18,5	18,6	14,3	14,5	10,6	10,1	8,1	7,6
38,0			28,5	31,0	23,5	18,0	18,1	13,9	14,0	10,3	9,9	7,8	7,4
40,0				28,5	22,5	17,6	17,6	13,5	13,6	9,9	9,6	7,5	7,2
42,0				26,0	21,5	17,1	17,1	13,1	13,2	9,6	9,4	7,2	7,0
44,0				23,0	20,5	16,6	16,7	12,7	12,8	9,3	9,2	6,9	6,8
46,0					19,7	16,2	16,2	12,3	12,3	9,0	9,0	6,7	6,6
48,0					18,8	15,8	15,8	11,8	11,7	8,7	8,8	6,4	6,4
50,0					17,9	15,3	15,4	11,4	11,2	8,4	8,5	6,2	6,3
52,0						15,0	15,0	10,9	10,9	8,1	8,3	5,9	6,1
54,0						14,6	14,6	10,5	10,6	7,9	8,0	5,7	5,9
56,0							14,2	10,2	10,3	7,6	7,7	5,4	5,7
58,0								9,9	10,0	7,3	7,5	5,2	5,4
60,0								9,6	9,7	7,1	7,2	5,0	5,2
62,0									9,4	6,9	7,0	4,8	5,0
64,0										6,6	6,7	4,6	4,8
66,0										6,4	6,5	4,4	4,6
68,0											6,2	4,2	4,4
70,0												4,1	4,2
72,0												3,9	4,0

Luffing jib • Wippspitzenausleger • Volée variable • Plumín de angulación variable • Jib a volata variable

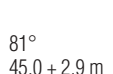
28

 81°  
 35,3 + 2,9 m  
 25 - 73  
 0°/22° \*  
 8,9 m  
 360°  
 120 t  
 **DIN/ISO**

m		35,3 + 2,9											
m	25	31	37	43	49	55		61		67		73	
	0°	0°	0°	0°	0°	0°	22°	0°	22°	0°	22°	0°	22°
15,0	52,5												
16,0	52,5	45,0											
18,0	49,0	45,0	36,5										
20,0	46,0	43,0	36,5	29,5									
22,0	43,5	41,0	36,5	29,5	23,0								
24,0	40,5	38,5	35,0	29,0	23,0	18,4		14,5					
26,0	38,5	36,5	34,0	29,0	22,5	18,0	18,1	14,4		10,8			
28,0	36,5	34,5	32,5	28,5	22,0	17,7	17,8	14,1		10,8		8,3	
30,0	34,5	33,0	31,0	28,0	22,0	17,4	17,5	13,8	13,9	10,5		8,2	
32,0		31,0	29,5	27,0	21,5	17,1	17,1	13,4	13,6	10,2		7,9	
34,0		30,0	28,0	26,0	21,0	16,8	16,8	13,1	13,3	10,0	10,2	7,7	
36,0		28,5	27,0	25,0	20,5	16,4	16,5	12,9	13,0	9,7	9,9	7,4	7,6
38,0			26,0	24,0	20,5	16,1	16,2	12,6	12,7	9,4	9,6	7,2	7,4
40,0			25,0	23,0	20,0	15,8	15,8	12,2	12,4	9,2	9,4	7,0	7,1
42,0				22,5	19,6	15,5	15,5	11,9	12,1	8,9	9,1	6,7	6,9
44,0				21,5	19,3	15,2	15,2	11,5	11,7	8,7	8,9	6,5	6,7
46,0				21,0	18,9	14,8	14,9	11,1	11,3	8,4	8,6	6,3	6,5
48,0					18,6	14,5	14,6	10,8	10,9	8,2	8,4	6,1	6,3
50,0					18,2	14,2	14,3	10,5	10,6	8,0	8,1	5,8	6,1
52,0					17,9	13,9	13,9	10,2	10,3	7,7	7,9	5,6	5,9
54,0						13,6	13,6	10,0	10,1	7,5	7,6	5,4	5,7
56,0						13,3	13,3	9,7	9,8	7,3	7,4	5,2	5,4
58,0						13,0		9,5	9,5	7,1	7,2	5,0	5,2
60,0								9,2	9,3	6,8	6,9	4,8	5,0
62,0								9,0	9,0	6,6	6,7	4,7	4,8
64,0								8,8		6,4	6,5	4,5	4,6
66,0										6,2	6,3	4,3	4,5
68,0										6,0	6,1	4,1	4,3
70,0										5,8		4,0	4,1
72,0												3,8	3,9
74,0												3,7	3,7

 81°  
 45,0 + 2,9 m  
 25 - 73  
 0°/22° \*  
 8,9 m  
 360°  
 120 t  
 **DIN/ISO**

m		45,0 + 2,9											
m	25	31	37	43	49	55		61		67		73	
	0°	0°	0°	0°	0°	0°	22°	0°	22°	0°	22°	0°	22°
18,0	39,0												
20,0	37,5	32,0											
22,0	35,0	31,0	26,0	20,5									
24,0	32,5	29,5	26,0	20,5	16,9								
26,0	30,5	28,5	25,5	20,5	16,9	13,5		10,5					
28,0	28,5	27,0	25,0	20,5	16,8	13,5	13,5	10,5		8,2			
30,0	27,0	25,5	24,0	20,5	16,7	13,4	13,4	10,5		8,2		6,2	
32,0	25,5	24,5	23,0	20,5	16,5	13,3	13,3	10,4	10,4	8,2		6,2	
34,0		23,0	22,0	20,5	16,4	13,1	13,1	10,2	10,3	8,1		6,2	
36,0		22,5	21,0	19,5	16,3	13,0	13,0	10,1	10,2	7,9	8,0	6,0	
38,0		21,5	20,0	18,7	16,1	12,8	12,9	9,9	10,0	7,8	7,9	5,9	6,0
40,0			19,4	18,0	16,0	12,7	12,7	9,8	9,9	7,6	7,7	5,8	5,9
42,0			18,6	17,3	15,8	12,5	12,6	9,6	9,7	7,5	7,6	5,6	5,8
44,0			17,8	16,6	15,4	12,4	12,4	9,5	9,6	7,3	7,4	5,5	5,7
46,0				15,9	15,0	12,2	12,2	9,3	9,4	7,2	7,3	5,3	5,5
48,0				15,4	14,6	12,1	12,1	9,2	9,2	7,0	7,1	5,2	5,4
50,0					14,1	11,8	11,9	9,0	9,1	6,9	7,0	5,0	5,2
52,0					13,6	11,6	11,7	8,8	8,9	6,7	6,8	4,9	5,1
54,0					13,1	11,4	11,4	8,7	8,7	6,6	6,7	4,8	4,9
56,0						11,2	11,2	8,5	8,6	6,4	6,5	4,6	4,8
58,0						11,0	11,0	8,4	8,4	6,3	6,4	4,5	4,6
60,0						10,9		8,2	8,2	6,1	6,2	4,3	4,5
62,0								8,0	8,1	6,0	6,0	4,2	4,3
64,0								7,9	7,9	5,8	5,9	4,0	4,2
66,0								7,7		5,7	5,7	3,9	4,0
68,0										5,5	5,6	3,8	3,9
70,0										5,4	5,4	3,6	3,8
72,0										5,2		3,5	3,6
74,0												3,4	3,5
76,0												3,3	3,3

GMK7450

Load charts • Traglasten • Capacités de levage • Capacidades • Capacità

Luffing jib • Wippspitzenausleger • Volée variable • Plumín de angulación variable • Jib a volata variable

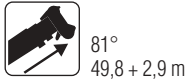

m		49,8 + 2,9											
m	25	31	37	43	49	55		61		67		73	
	0°	0°	0°	0°	0°	0°	22°	0°	22°	0°	22°	0°	22°
20,0	30,5												
22,0	30,0	26,0											
24,0	28,5	26,0	20,5	16,8									
26,0	27,0	25,0	20,5	16,8	13,2								
28,0	25,5	23,5	20,5	16,8	13,2	10,8		8,7					
30,0	24,0	23,0	20,5	16,8	13,2	10,8	10,7	8,7		6,6			
32,0	23,0	22,0	20,0	16,8	13,2	10,7	10,7	8,7	8,5	6,6			4,9
34,0		21,0	19,4	16,8	13,2	10,6	10,7	8,6	8,5	6,6			4,9
36,0		19,9	18,6	16,7	13,2	10,6	10,6	8,5	8,4	6,5			4,9
38,0		19,0	17,9	16,2	13,2	10,5	10,5	8,4	8,3	6,4	6,5		4,8
40,0			17,1	15,7	13,2	10,4	10,4	8,3	8,2	6,3	6,4		4,7
42,0			16,4	15,1	13,2	10,3	10,3	8,2	8,1	6,2	6,3		4,6
44,0			15,8	14,5	13,0	10,2	10,2	8,1	8,0	6,1	6,2		4,5
46,0				13,9	12,7	10,1	10,2	8,0	7,9	6,0	6,1		4,4
48,0				13,4	12,5	10,0	10,1	7,9	7,8	5,9	6,0		4,3
50,0					12,3	9,9	10,0	7,8	7,7	5,8	5,9		4,2
52,0					11,9	9,8	9,9	7,7	7,6	5,7	5,8		4,1
54,0					11,4	9,7	9,8	7,6	7,5	5,7	5,7		4,0
56,0					11,0	9,6	9,7	7,5	7,4	5,6	5,6		3,9
58,0						9,5	9,5	7,4	7,3	5,4	5,5		3,8
60,0						9,3	9,4	7,3	7,2	5,3	5,4		3,7
62,0							9,2	7,2	7,1	5,2	5,3		3,6
64,0								7,0	7,0	5,1	5,2		3,5
66,0								6,9	6,9	5,0	5,1		3,4
68,0								6,8	6,8	4,9	5,0		3,3
70,0										4,8	4,8		3,2
72,0										4,7	4,7		3,1
74,0										4,6			3,0
76,0													2,9
78,0													2,8
80,0													2,7

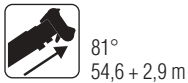

m		54,6 + 2,9											
m	25	31	37	43	49	55		61		67		73	
	0°	0°	0°	0°	0°	0°	22°	0°	22°	0°	22°	0°	22°
22,0	25,0												
24,0	25,0	20,5											
26,0	25,0	20,5	16,6	13,5									
28,0	23,5	20,5	16,6	13,5	10,8								
30,0	22,5	20,5	16,6	13,5	10,8	8,9		6,9					
32,0	21,5	19,6	16,6	13,5	10,8	8,9	8,8	6,9		5,3			
34,0	20,5	18,7	16,6	13,5	10,8	8,8	8,8	6,9	6,8	5,3			3,8
36,0		17,9	16,6	13,5	10,8	8,8	8,8	6,9	6,8	5,3			3,8
38,0		17,2	16,0	13,5	10,8	8,7	8,7	6,8	6,8	5,2	5,2		3,8
40,0		16,4	15,3	13,5	10,8	8,7	8,7	6,8	6,8	5,2	5,2		3,7
42,0			14,7	13,4	10,8	8,6	8,6	6,7	6,7	5,1	5,2		3,7
44,0			14,1	12,9	10,8	8,6	8,6	6,6	6,7	5,1	5,1		3,6
46,0			13,5	12,4	10,8	8,5	8,5	6,6	6,6	5,0	5,1		3,6
48,0				11,9	10,7	8,4	8,5	6,5	6,6	4,9	5,0		3,5
50,0				11,5	10,6	8,4	8,4	6,5	6,5	4,9	4,9		3,4
52,0				11,0	10,5	8,3	8,3	6,4	6,4	4,8	4,9		3,4
54,0					10,1	8,3	8,3	6,3	6,4	4,7	4,8		3,3
56,0					9,7	8,2	8,2	6,3	6,3	4,7	4,7		3,2
58,0					9,2	8,2	8,1	6,2	6,2	4,6	4,7		3,2
60,0						7,9	7,9	6,1	6,2	4,5	4,6		3,1
62,0						7,7		6,1	6,1	4,5	4,5		3,0
64,0						7,5		6,0	6,0	4,4	4,4		3,0
66,0								5,9	5,9	4,3	4,4		2,9
68,0								5,8		4,2	4,3		2,8
70,0										4,2	4,2		2,7
72,0										4,1	4,1		2,7
74,0										4,0			2,6
76,0													2,5
78,0													2,4
80,0													2,4

Luffing jib • Wippspitzenausleger • Volée variable • Plumín de angulación variable • Jib a volata variable

30



70°  
16,0 + 2,9 m



25 - 73  
0°/22° \*



8,9 m



360°



120 t



DIN/ISO

m		16,0 + 2,9												
m	25	31	37	43	49	55		61		67		73		
	0°	0°	0°	0°	0°	0°	22°	0°	22°	0°	22°	0°	22°	
18,0	69,5													
20,0	64,0													
22,0	59,5	58,0												
24,0	55,5	55,0												
26,0	51,0	50,5	46,0											
28,0	44,5	46,5	45,0	37,5										
30,0		42,5	42,0	36,5	29,0									
32,0		39,0	38,5	35,5	28,5									
34,0		34,0	36,0	35,0	27,5	21,0	21,0							
36,0			33,5	33,0	26,5	20,5	20,5	15,8						
38,0			31,0	30,5	26,0	19,8	19,9	15,2	15,4	11,6				
40,0			27,0	28,5	25,0	19,2	19,3	14,7	14,9	11,0			8,2	
42,0				27,0	24,5	18,6	19,1	14,2	14,4	10,4	9,7		7,9	
44,0				25,0	23,5	18,0	19,0	13,7	13,9	10,0	9,5		7,5	
46,0				22,0	22,5	17,5	18,9	13,3	13,4	9,7	9,3		7,2	
48,0					21,0	17,0	17,7	12,9	13,0	9,3	9,1		6,9	6,6
50,0					19,8	16,5	16,5	12,4	12,6	9,0	8,9		6,7	6,5
52,0					17,9	16,0	16,1	11,9	12,1	8,7	8,7		6,4	6,3
54,0						15,6	15,6	11,5	11,7	8,4	8,5		6,1	6,2
56,0						15,1	15,1	11,0	11,2	8,1	8,2		5,8	6,0
58,0						14,2		10,5	10,7	7,8	8,0		5,6	5,8
60,0								10,2	10,2	7,5	7,7		5,4	5,6
62,0								9,9	9,7	7,3	7,4		5,2	5,4
64,0								9,6		7,0	7,1		4,9	5,1
66,0										6,8	6,9		4,7	4,9
68,0										6,6	6,6		4,5	4,7
70,0										6,3			4,3	4,5
72,0													4,2	4,2
74,0													4,0	4,0
76,0													3,8	



70°  
25,7 + 2,9 m



25 - 73  
0°/22° \*



8,9 m



360°



120 t



DIN/ISO

m		25,7 + 2,9												
m	25	31	37	43	49	55		61		67		73		
	0°	0°	0°	0°	0°	0°	22°	0°	22°	0°	22°	0°	22°	
22,0	54,0													
24,0	50,5													
26,0	47,0	46,0												
28,0	43,0	42,5	42,0											
30,0	39,0	38,5	38,5											
32,0	36,0	35,5	35,5	34,0										
34,0		33,0	32,5	32,0	26,0									
36,0		30,5	30,5	29,5	25,5									
38,0		28,5	28,0	27,5	25,0	19,3	19,3							
40,0			26,5	26,0	24,0	18,8	18,8	14,5						
42,0			24,5	24,0	23,5	18,3	18,3	14,1	14,2	10,4				
44,0			23,0	22,5	22,5	17,8	17,8	13,6	13,8	10,1			7,6	
46,0				21,5	21,0	17,3	17,3	13,2	13,4	9,7	9,5		7,3	
48,0				20,0	20,0	16,8	16,9	12,8	13,0	9,4	9,3		7,1	
50,0				19,1	18,9	16,4	16,4	12,4	12,6	9,1	9,1		6,8	
52,0					17,9	16,0	16,0	12,0	12,2	8,8	8,9		6,5	6,5
54,0					16,9	15,5	15,6	11,5	11,8	8,5	8,7		6,3	6,3
56,0					16,0	15,1	15,2	11,0	11,3	8,2	8,4		6,0	6,2
58,0						14,7	14,7	10,6	10,7	8,0	8,1		5,8	6,0
60,0						14,2	14,2	10,3	10,4	7,7	7,8		5,6	5,8
62,0						13,5		10,0	10,1	7,4	7,6		5,3	5,6
64,0								9,8	9,8	7,2	7,3		5,1	5,3
66,0								9,5	9,5	7,0	7,1		4,9	5,1
68,0								9,2		6,7	6,8		4,7	4,9
70,0										6,5	6,6		4,5	4,7
72,0										6,3	6,3		4,3	4,4
74,0													4,1	4,3
76,0													4,0	4,1
78,0													3,8	3,9

GMK7450

Load charts • Traglasten • Capacités de levage • Capacidades • Capacità

Luffing jib • Wippspitzenausleger • Volée variable • Plumín de angulación variable • Jib a volata variable



70°  
35,3 + 2,9 m



25 - 73  
0°/22° \*



8,9 m



360°



120 t



DIN/ISO

m		35,3 + 2,9												
m	25	31	37	43	49	55		61		67		73		
	0°	0°	0°	0°	0°	0°	22°	0°	22°	0°	22°	0°	22°	
26,0	34,0													
28,0	32,0													
30,0	30,5	29,0												
32,0	29,0	27,5	26,0											
34,0	27,5	26,0	25,0											
36,0	26,5	25,0	23,5	22,5										
38,0		24,0	22,5	21,5										
40,0		23,0	22,0	20,5	20,0									
42,0		22,0	21,0	19,8	19,2	16,7	16,6							
44,0			20,0	19,0	18,4	16,7	16,3	12,7						
46,0			19,3	18,2	17,6	16,2	16,0	12,4	12,4	9,2				
48,0			18,6	17,5	16,9	15,6	15,6	12,1	12,1	9,0			6,7	
50,0				16,8	16,2	15,0	15,1	11,7	11,9	8,8			6,6	
52,0				16,3	15,6	14,5	14,6	11,3	11,4	8,5	8,7		6,4	
54,0				15,6	15,0	13,9	14,0	10,9	11,0	8,3	8,4		6,1	
56,0					14,5	13,5	13,5	10,6	10,7	8,0	8,2	5,9	6,2	
58,0					13,8	13,0	13,0	10,3	10,4	7,8	8,0	5,7	5,9	
60,0					13,0	12,5	12,5	10,1	10,2	7,6	7,7	5,5	5,7	
62,0						12,0	11,9	9,8	9,9	7,3	7,5	5,3	5,5	
64,0						11,3	11,3	9,6	9,6	7,1	7,3	5,1	5,3	
66,0							10,8	9,3	9,4	6,9	7,0	4,9	5,1	
68,0								9,1	9,1	6,7	6,8	4,7	4,9	
70,0								8,9	8,9	6,5	6,6	4,6	4,7	
72,0									8,6		6,3	6,4	4,4	4,5
74,0											6,1	6,2	4,2	4,3
76,0											5,9	5,9	4,0	4,2
78,0													3,9	4,0
80,0													3,7	3,8
82,0													3,6	3,6



70°  
45,0 + 2,9 m



25 - 73  
0°/22° \*



DIN/ISO



360°



120 t

m		45,0 + 2,9											
m	25	31	37	43	49	55		61		67		73	
	0°	0°	0°	0°	0°	0°	22°	0°	22°	0°	22°	0°	22°
30,0	23,0												
32,0	23,0												
34,0	21,5	19,6											
36,0	20,5	18,6											
38,0	19,1	17,7	16,8										
40,0	18,0	16,9	16,0	14,9									
42,0		16,2	15,3	14,2									
44,0		15,5	14,6	13,6	13,1								
46,0		14,9	14,0	13,0	12,5	11,1							
48,0			13,4	12,4	11,9	11,1	11,2	9,7					
50,0			12,9	11,9	11,4	10,6	10,7	9,6		7,4			
52,0			12,4	11,5	11,0	10,2	10,2	9,4	9,6	7,4			5,4
54,0				11,1	10,6	9,7	9,8	9,1	9,2	7,2			5,4
56,0				10,7	10,2	9,3	9,4	8,7	8,8	7,1	7,2		5,2
58,0				10,3	9,8	8,9	9,0	8,3	8,5	6,9	7,0		5,1
60,0					9,4	8,5	8,6	8,0	8,1	6,8	6,9		5,0
62,0					9,1	8,2	8,2	7,6	7,7	6,6	6,7	4,8	5,0
64,0					8,7	7,8	7,9	7,3	7,4	6,5	6,6	4,7	4,8
66,0						7,5	7,5	7,0	7,1	6,3	6,4	4,5	4,7
68,0						7,2	7,2	6,7	6,8	6,1	6,3	4,4	4,5
70,0						6,9		6,4	6,5	5,9	6,0	4,2	4,4
72,0								6,2	6,2	5,7	5,8	4,1	4,2
74,0								5,9	5,9	5,4	5,6	4,0	4,1
76,0										5,2	5,3	3,8	3,9
78,0										5,0	5,1	3,7	3,8
80,0										4,8	4,8	3,5	3,7
82,0												3,4	3,5
84,0												3,3	3,4
86,0												3,2	3,2

Luffing jib • Wippspitzenausleger • Volée variable • Plumín de angulación variable • Jib a volata variable

32



70°  
49,8 + 2,9 m



25 - 73  
0°/22° \*



8,9 m



360°



120 t



DIN/ISO

m		49,8 + 2,9											
m	25	31	37	43	49	55		61		67		73	
	0°	0°	0°	0°	0°	0°	22°	0°	22°	0°	22°	0°	22°
34,0	18,2												
36,0	17,3	16,2											
38,0	16,5	15,4											
40,0	15,7	14,7	13,8										
42,0	15,0	14,0	13,1										
44,0		13,4	12,5	11,5									
46,0		12,8	12,0	11,1	10,7								
48,0		12,3	11,5	10,7	10,2	8,8							
50,0			11,1	10,2	9,8	8,8	8,9	7,8					
52,0			10,7	9,8	9,3	8,4	8,5	7,8		6,2			
54,0			10,3	9,4	8,9	8,0	8,1	7,5	7,5	6,2			
56,0				9,0	8,5	7,6	7,7	7,1	7,2	6,1		4,4	
58,0				8,6	8,1	7,3	7,3	6,8	7,0	5,9	6,0	4,3	
60,0				8,2	7,8	6,9	7,0	6,5	6,7	5,7	5,9	4,2	
62,0					7,5	6,6	6,7	6,2	6,3	5,5	5,7	4,1	
64,0					7,1	6,3	6,4	5,9	6,0	5,3	5,5	4,0	4,2
66,0					6,8	6,0	6,1	5,6	5,7	5,1	5,3	3,9	4,1
68,0						5,8	5,8	5,4	5,5	4,8	5,0	3,8	4,0
70,0						5,5	5,5	5,1	5,2	4,6	4,7	3,7	3,9
72,0						5,2		4,9	4,9	4,3	4,5	3,6	3,8
74,0								4,7	4,7	4,1	4,3	3,5	3,7
76,0								4,4	4,5	3,9	4,0	3,3	3,5
78,0								4,2		3,7	3,8	3,2	3,4
80,0										3,5	3,6	3,0	3,2
82,0										3,4	3,4	2,9	3,0
84,0										3,2		2,7	2,8
86,0												2,5	2,6
88,0												2,4	2,5



70°  
54,6 + 2,9 m



25 - 73  
0°/22° \*



8,9 m



360°



120 t



DIN/ISO

m		54,6 + 2,9											
m	25	31	37	43	49	55		61		67		73	
	0°	0°	0°	0°	0°	0°	22°	0°	22°	0°	22°	0°	22°
36,0	16,1												
38,0	15,3	13,5											
40,0	14,6	12,9											
42,0	13,9	12,3	11,4										
44,0	13,2	11,7	11,1										
46,0		11,4	10,6	9,6									
48,0		10,9	10,1	9,2									
50,0		10,4	9,7	8,7	8,3	7,0							
52,0			9,3	8,3	7,9	7,0	7,0	5,8					
54,0			8,9	8,0	7,5	6,6	6,7	5,8					
56,0			8,5	7,6	7,2	6,3	6,4	5,7	5,6	4,8			
58,0				7,3	6,8	6,0	6,0	5,4	5,6	4,8		3,5	
60,0				7,0	6,5	5,7	5,7	5,1	5,3	4,6	4,6	3,5	
62,0				6,6	6,2	5,4	5,4	4,8	5,0	4,3	4,6	3,4	
64,0					5,9	5,1	5,2	4,6	4,7	4,1	4,3	3,3	
66,0					5,6	4,8	4,9	4,3	4,5	3,9	4,1	3,2	3,3
68,0					5,4	4,6	4,6	4,1	4,2	3,7	3,9	3,1	3,3
70,0						4,4	4,4	3,9	4,0	3,5	3,7	2,9	3,2
72,0						4,1	4,1	3,6	3,7	3,2	3,4	2,7	3,0
74,0							3,9	3,5	3,5	3,1	3,2	2,5	2,8
76,0								3,3	3,3	2,9	3,0	2,3	2,6
78,0								3,1	3,1	2,7	2,8	2,2	2,4
80,0									2,9	2,5	2,6	2,0	2,2
82,0										2,4	2,5	1,9	2,0
84,0										2,2	2,3	1,7	1,9
86,0											2,0		1,7

GMK7450



Luffing jib • Wippspitzenausleger • Volée variable • Plumín de angulación variable • Jib a volata variable



m		16,0 + 2,9													
m	25	31	37	43	49	55		61		67		73			
	0°	0°	0°	0°	0°	0°	22°	0°	22°	0°	22°	0°	22°		
26,0	48,5														
28,0	44,5	44,0													
30,0	40,5	40,0													
32,0	37,5	37,0	36,5												
34,0		34,0	34,0												
36,0		32,0	31,5	31,0											
38,0		29,5	29,5	29,0											
40,0			27,5	27,0	26,0										
42,0			25,5	25,5	25,0										
44,0			24,0	24,0	23,5	18,9	19,0								
46,0				22,5	22,0	18,3	18,4	14,0							
48,0				21,0	21,0	17,8	17,8	13,5							
50,0				20,0	19,7	17,2	17,3	13,0	13,2	9,5					
52,0					18,7	16,7	16,8	12,6	12,8	9,1					
54,0					17,7	16,2	16,3	12,2	12,3	8,8			6,5		
56,0						15,8	15,8	11,6	11,7	8,5	8,6		6,2		
58,0						15,3	15,3	11,0	11,1	8,2	8,4		6,0		
60,0							14,9	10,7	10,7	7,9	8,1		5,7	5,9	
62,0								10,3	10,4	7,7	7,8		5,5	5,7	
64,0								10,0	10,1	7,4	7,5		5,3	5,5	
66,0									9,7	9,7	7,1	7,2		5,0	5,2
68,0											6,9	7,0		4,8	5,0
70,0											6,7	6,7		4,6	4,8
72,0											6,4			4,4	4,6
74,0														4,3	4,4
76,0														4,1	4,1
78,0														3,9	

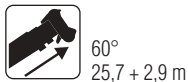

m		25,7 + 2,9													
m	25	31	37	43	49	55		61		67		73			
	0°	0°	0°	0°	0°	0°	22°	0°	22°	0°	22°	0°	22°		
30,0	35,5														
32,0	32,5														
34,0	30,0	30,0													
36,0	28,0	27,5													
38,0		25,5	25,5												
40,0		24,0	23,5												
42,0		22,5	22,0	21,5											
44,0			21,0	20,0											
46,0			19,5	19,0	18,6										
48,0			18,4	17,9	17,5	17,1									
50,0				16,9	16,5	16,1	16,1								
52,0				16,0	15,6	15,2	15,2	12,9							
54,0					14,8	14,4	14,4	12,6							
56,0					14,0	13,6	13,6	12,2	12,3	8,9					
58,0					13,3	12,9	12,9	11,8	11,9	8,6					
60,0					12,6	12,2	12,2	11,5	11,6	8,3	8,5		6,1		
62,0						11,6	11,6	10,9	10,8	8,0	8,2		5,8		
64,0						11,0	11,0	10,4	10,5	7,8	7,9		5,6		
66,0							10,4	10,1	10,2	7,5	7,6		5,4	5,6	
68,0								9,7	9,7	7,3	7,4		5,2	5,4	
70,0								9,2	9,2	7,0	7,1		5,0	5,2	
72,0									8,7	6,8	6,9		4,7	4,9	
74,0										6,6	6,6		4,6	4,7	
76,0										6,3	6,4		4,4	4,5	
78,0											6,1		4,2	4,3	
80,0													4,0	4,1	
82,0													3,8	3,9	
84,0														3,7	

Luffing jib • Wippspitzenausleger • Volée variable • Plumín de angulación variable • Jib a volata variable

34



60°  
35,3 + 2,9 m



25 - 73  
0°/22° \*



8,9 m



360°



120 t



DIN/ISO

m		35,3 + 2,9											
m	25	31	37	43	49	55		61		67		73	
	0°	0°	0°	0°	0°	0°	22°	0°	22°	0°	22°	0°	22°
36,0	23,0												
38,0	22,5												
40,0	21,5	20,5											
42,0	20,0	19,4											
44,0		18,5	17,6										
46,0		17,4	16,9										
48,0		16,3		15,3									
50,0			15,1	14,5									
52,0			14,2	13,7	13,3								
54,0			13,4	12,9	12,5								
56,0				12,2	11,8	11,4	11,4						
58,0				11,6	11,2	10,8	10,8	10,4					
60,0				10,9	10,6	10,2	10,2	9,8	9,8				
62,0					10,0	9,6	9,6	9,3	9,3	8,0			
64,0					9,5	9,1	9,1	8,8	8,8	7,8			5,7
66,0					9,0	8,6	8,6	8,3	8,3	7,6	7,7		5,5
68,0						8,2	8,2	7,9	7,9	7,4	7,5		5,3
70,0						7,7	7,7	7,4	7,4	7,1	7,2		5,1
72,0						7,3		7,0	7,0	6,8	6,8	4,9	5,1
74,0								6,6	6,6	6,4	6,4	4,7	4,9
76,0								6,3	6,3	6,1	6,1	4,6	4,7
78,0										5,7	5,7	4,4	4,5
80,0										5,4	5,4	4,2	4,4
82,0										5,0	5,0	4,1	4,2
84,0												3,9	4,0
86,0												3,7	3,8
88,0												3,6	3,6



60°  
45,0 + 2,9 m



25 - 73  
0°/22° \*



360°



120 t



DIN/ISO

m		45,0 + 2,9											
m	25	31	37	43	49	55		61		67		73	
	0°	0°	0°	0°	0°	0°	22°	0°	22°	0°	22°	0°	22°
42,0	15,6												
44,0	14,4												
46,0	13,5	12,1											
48,0	12,6	11,6											
50,0		11,2	10,5										
52,0		10,8	10,0										
54,0		10,3	9,6	8,7									
56,0			9,2	8,3									
58,0			8,8	8,0	7,5								
60,0			8,5	7,6	7,2	6,4	6,1						
62,0				7,3	6,8	6,0	6,1						
64,0				7,0	6,5	5,7	5,8	6,9					
66,0					6,2	5,5	5,5	5,0	5,1				
68,0					6,0	5,2	5,2	4,7	4,8	4,2			
70,0					5,7	4,9	4,9	4,4	4,6	4,0			3,8
72,0						4,7	4,7	4,2	4,3	3,8	4,0		3,8
74,0						4,4	4,4	4,0	4,1	3,6	3,8		3,6
76,0						4,2		3,8	3,9	3,4	3,6	3,4	3,5
78,0								3,6	3,6	3,2	3,3	3,3	3,5
80,0								3,4	3,4	3,0	3,1	3,1	3,2
82,0								3,2		2,8	2,9	2,9	3,0
84,0										2,6	2,7	2,7	2,7
86,0										2,5	2,5	2,4	2,5
88,0										2,3		2,2	2,2
90,0												2,0	2,0
92,0												1,7	1,8

GMK7450

Load charts • Traglasten • Capacités de levage • Capacidades • Capacità

Luffing jib • Wippspitzenausleger • Volée variable • Plumín de angulación variable • Jib a volata variable



60°  
49,8 + 2,9 m



25 - 73  
0°/22° \*



8,9 m



360°



120 t

35



m		49,8 + 2,9									
m	25	31	37	43	49	55	61				
	0°	0°	0°	0°	0°	0°	22°	0°	22°		
44,0	11,5										
46,0	11,2										
48,0	10,7	9,8									
50,0	10,2	9,4									
52,0		9,0	8,2								
54,0		8,6	7,9								
56,0		8,2	7,5	6,6							
58,0			7,2	6,3							
60,0			6,9	6,0							
62,0			6,5	5,7	5,2						
64,0				5,4	5,0	4,2	4,0				
66,0				5,2	4,7	3,9	4,0				
68,0				4,9	4,5	3,7	3,7			3,3	
70,0					4,2	3,4	3,5			3,1	3,2
72,0					4,0	3,2	3,3			2,9	3,0
74,0					3,8	3,0	3,1			2,7	2,8
76,0						2,8	2,9			2,5	2,6
78,0						2,6	2,7			2,3	2,4
80,0						2,5				2,1	2,2
82,0										2,0	2,0
84,0										1,8	1,8
86,0										1,7	



60°  
54,6 + 2,9 m



31-49  
0°



8,9 m



360°



120 t



m		54,6 + 2,9										
m	31	37	43	49								
	0°	0°	0°	0°								
52,0	7,5											
54,0	7,1											
56,0	6,8	6,1										
58,0	6,5	5,8										
60,0	6,2	5,5	4,7									
62,0		5,3	4,4									
64,0		5,0	4,2									
66,0			3,9	3,5								
68,0			3,7	3,2								
70,0			3,5	3,0								
72,0				2,9								
74,0				2,7								
76,0				2,5								

GMK7450

**Mega-Wing-Lift**  
 Working range • Arbeitsbereiche • Diagramme de levage • Gama de trabajo • Area di lavoro

36

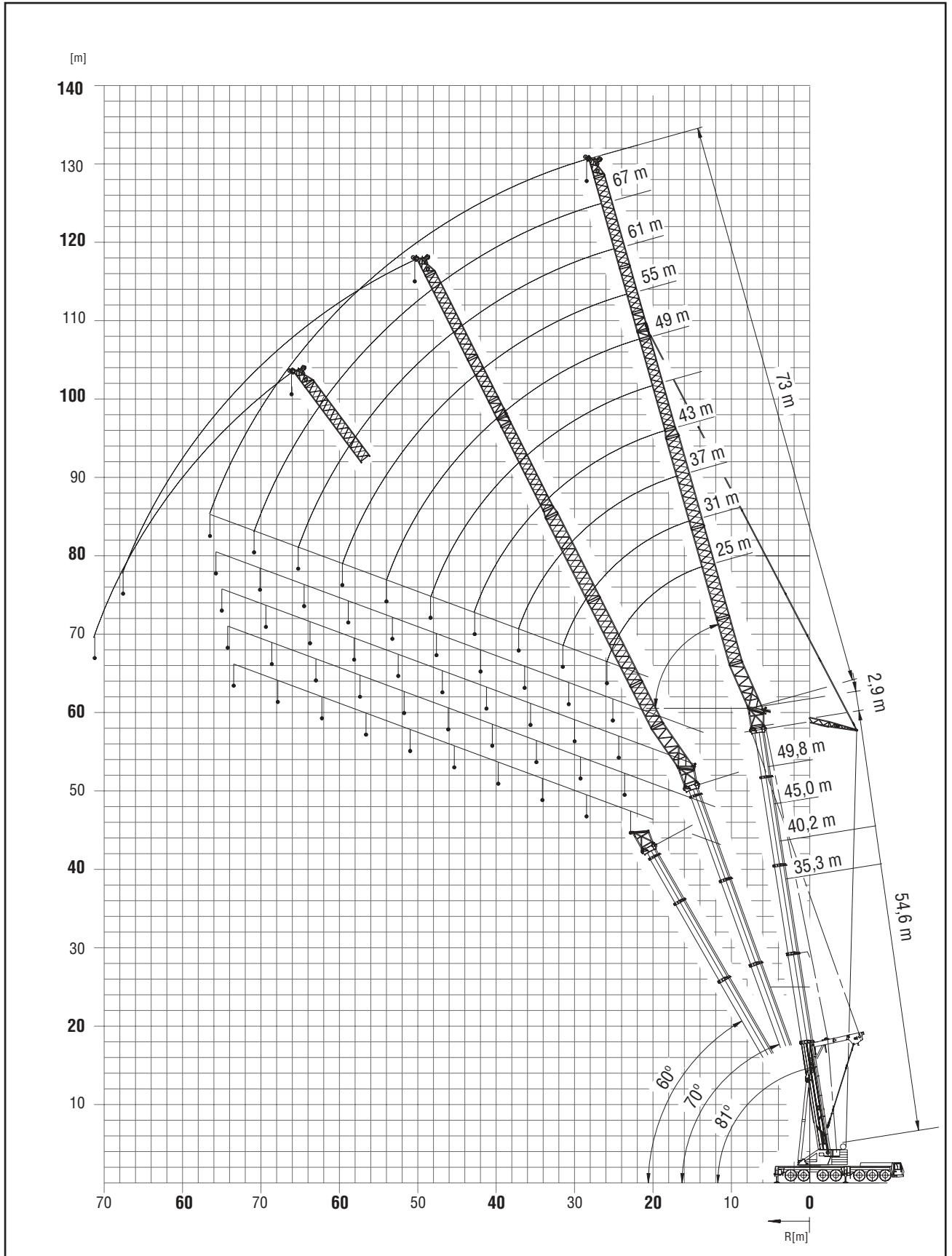

GMK7450

**Mega-Wing-Lift**

Luffing jib • Wippspitzenausleger • Volée variable • Plumín de angulación variable • Jib a volata variable



81°  
35,3 + 2,9 m

25 - 73  
0°/22° \*



8,9 m



360°



160 t



DIN/ISO

m		35,3 + 2,9											
m	25	31	37	43	49	55		61		67		73	
	0°	0°	0°	0°	0°	0°	22°	0°	22°	0°	22°	0°	22°
15,0	64,0												
16,0	63,5	48,5											
18,0	59,0	48,5	38,5										
20,0	55,0	48,5	38,5	31,5									
22,0	51,0	48,5	38,5	31,5	26,5								
24,0	48,0	48,5	38,5	31,5	26,5	21,5							
26,0	45,5	48,5	38,5	31,5	26,5	21,5	22,0	17,9					
28,0	43,5	47,0	38,5	31,5	26,5	21,5	22,0	17,9		14,9			
30,0		45,0	38,5	31,5	26,5	21,5	22,0	17,9	18,5	14,9			11,9
32,0		42,5	38,5	31,5	26,5	21,5	22,0	17,9	18,5	14,9			11,9
34,0		37,0	38,5	31,5	26,5	21,5	22,0	17,9	18,5	14,9	14,2		11,9
36,0			37,0	31,5	26,5	21,5	22,0	17,9	18,4	14,9	14,0		11,9
38,0			34,5	31,5	26,5	21,5	22,0	17,9	18,3	14,9	13,7		11,9
40,0			29,5	31,5	26,5	21,5	22,0	17,9	18,1	14,9	13,4		11,9
42,0				30,5	26,5	21,5	22,0	17,9	17,9	14,9	12,9		11,8
44,0				27,5	26,5	21,5	22,0	17,9	17,8	14,9	12,3		11,5
46,0				23,5	26,0	21,0	21,5	17,9	17,7	14,9	11,8		11,2
48,0					25,5	21,0	21,5	17,9	17,6	14,7	11,6		10,9
50,0					22,5	20,5	21,0	17,9	17,5	14,4	11,4		10,6
52,0					19,3	20,0	20,5	17,9	17,5	13,8	11,2		10,3
54,0						19,9	20,5	17,9	17,5	13,3	11,1		10,0
56,0						18,5	18,7	17,9	17,4	12,8	10,9		9,7
58,0						15,9		17,9	17,4	12,4	10,8		9,4
60,0								17,3	17,4	12,1	10,7		9,1
62,0								15,4		11,8	10,6		8,9
64,0								13,2		11,5	10,5		8,6
66,0										11,2	10,5		8,4
68,0										11,0			8,2
70,0													8,0
72,0													7,8
74,0													7,7
76,0													7,2



81°  
45,0 + 2,9 m



25 - 73  
0°/22° \*



8,9 m



360°



160 t





DIN/ISO

m		45,0 + 2,9											
m	25	31	37	43	49	55		61		67		73	
	0°	0°	0°	0°	0°	0°	22°	0°	22°	0°	22°	0°	22°
18,0	54,5												
20,0	51,0	46,5											
22,0	48,5	45,0	36,5										
24,0	47,0	43,0	36,5	29,0									
26,0	46,0	41,0	36,5	29,0	24,5								
28,0	45,0	40,0	36,5	29,0	24,5	20,0	20,5						
30,0	43,0	39,0	35,5	29,0	24,5	20,0	20,5	16,6		13,9			
32,0	38,5	38,0	34,5	29,0	24,5	20,0	20,5	16,6		13,9			11,0
34,0		36,5	33,5	29,0	24,5	20,0	20,5	16,6	17,2	13,9			11,0
36,0		34,0	32,5	29,0	24,5	20,0	20,5	16,6	17,2	13,9	13,8		11,0
38,0			31,5	29,0	24,5	20,0	20,5	16,6	17,2	13,9	13,6		11,0
40,0			30,5	28,0	24,5	20,0	20,5	16,6	17,2	13,9	13,1		11,0
42,0			28,5	27,5	24,5	20,0	20,5	16,6	17,2	13,9	12,4		11,0
44,0				26,5	24,5	20,0	20,5	16,6	17,2	13,9	12,1		11,0
46,0				24,5	24,5	20,0	20,5	16,6	17,2	13,9	11,9		11,0
48,0					24,0	19,9	20,5	16,6	17,1	13,9	11,7		10,9
50,0					23,0	19,8	20,5	16,6	17,0	13,9	11,5		10,7
52,0					21,5	19,6	20,0	16,6	17,0	13,9	11,3		10,4
54,0					20,5	19,3	19,9	16,6	17,0	13,6	11,1		10,1
56,0						18,9	19,3	16,6	17,0	13,2	11,0		9,9
58,0						18,6	18,7	16,6	17,0	12,7	10,9		9,6
60,0								16,6	17,0	12,3	10,8		9,3
62,0								16,6	16,0	12,0	10,7		9,1
64,0								16,6	16,1	11,7	10,6		8,8
66,0										11,4	10,5		8,6
68,0										11,2	10,5		8,4
70,0										11,0			8,2
72,0													8,0
74,0													7,8
76,0													7,7
													7,3
													7,3

**Mega-Wing-Lift**  
**Luffing jib • Wippspitzenausleger • Volée variable • Plumín de angulación variable • Jib a volata variable**

 81°  
 49,8 + 2,9 m

 25 - 73  
 0°/22° \*

 8,9 m

 360°

 160 t

 **DIN/ISO**

m		49,8 + 2,9											
m	25	31	37	43	49	55		61		67		73	
	0°	0°	0°	0°	0°	0°	22°	0°	22°	0°	22°	0°	22°
20,0	46,0												
22,0	44,0	39,5											
24,0	42,5	37,5	33,5										
26,0	41,5	36,5	33,0	27,0									
28,0	40,0	35,5	32,0	27,0	23,0	18,7							
30,0	37,5	34,5	31,0	27,0	23,0	18,7	19,1						
32,0	35,0	33,5	30,5	27,0	23,0	18,7	19,1	15,5		12,9			
34,0		32,0	29,5	26,5	23,0	18,7	19,1	15,5		12,9		10,3	
36,0		30,0	29,0	26,0	23,0	18,7	19,1	15,5	16,0	12,9		10,3	
38,0		28,5	27,5	25,0	23,0	18,7	19,1	15,5	16,0	12,9	13,2	10,3	
40,0			26,0	24,0	23,0	18,7	19,1	15,5	16,0	12,9	12,3	10,3	
42,0			24,5	23,0	22,5	18,7	19,1	15,5	16,0	12,9	12,1	10,3	9,4
44,0			23,0	22,0	22,0	18,7	19,1	15,5	16,0	12,9	12,0	10,3	9,2
46,0				21,0	21,0	18,7	19,1	15,5	16,0	12,9	11,8	10,3	9,0
48,0				19,9	20,5	18,6	19,0	15,5	16,0	12,9	11,6	10,3	8,8
50,0				18,8	19,6	18,1	18,5	15,5	16,0	12,9	11,5	10,3	8,6
52,0					18,8	17,7	18,0	15,5	16,0	12,9	11,3	10,3	8,4
54,0					18,0	17,2	17,4	15,5	16,0	12,9	11,2	10,0	8,3
56,0					17,1	16,5	16,7	15,5	15,9	12,9	11,0	9,8	8,1
58,0						15,9	16,1	15,3	15,6	12,7	10,8	9,6	8,0
60,0							15,2	14,8	15,0	12,4	10,7	9,4	7,8
62,0								14,3	14,5	12,0	10,6	9,1	7,7
64,0								13,5	13,9	11,7	10,6	8,9	7,6
66,0									12,7	11,5	10,5	8,6	7,5
68,0									11,8	11,3	10,4	8,4	7,4
70,0										11,0		8,2	7,4
72,0											10,6	8,0	7,3
74,0												7,9	7,3
76,0												7,7	7,2
78,0													7,6

 81°  
 54,6 + 2,9 m

 25 - 73  
 0°/22° \*

 8,9 m

 360°

 160 t

 **DIN/ISO**

m		54,6 + 2,9												
m	25	31	37	43	49	55		61		67		73		
	0°	0°	0°	0°	0°	0°	22°	0°	22°	0°	22°	0°	22°	
22,0	39,5													
24,0	37,0	34,0												
26,0	34,5	32,5	29,5	25,0										
28,0	32,5	30,5	28,5	25,0	21,5									
30,0	30,5	28,5	27,0	24,0	21,5		17,2							
32,0	28,5	27,0	25,5	23,5	21,5		17,2	17,6						
34,0	26,5	25,5	24,0	22,5	21,5		17,2	17,6	14,3		11,4			
36,0		23,5	22,5	21,5	21,0		17,2	17,6	14,3		11,4		9,5	
38,0		22,0	21,5	20,5	20,5		17,2	17,6	14,3	14,9	11,4		9,5	
40,0		21,0	20,5	19,3	19,5		17,2	17,6	14,3	14,9	11,4	11,9	9,5	
42,0			19,2	18,4	18,7		17,1	17,4	14,3	14,9	11,4	11,8	9,5	
44,0			18,1	17,4	17,9		16,6	16,8	14,3	14,9	11,4	11,7	9,5	9,1
46,0			16,9	16,5	17,1		16,0	15,8	14,3	14,9	11,4	11,6	9,5	9,0
48,0				15,6	16,4		15,5	14,5	14,3	14,7	11,4	11,4	9,5	8,8
50,0				14,8	15,6		14,6	12,9	13,9	13,9	11,4	11,3	9,5	8,6
52,0					14,9		13,7	12,6	13,5	13,2	11,4	11,2	9,5	8,4
54,0					14,2		12,8	12,4	12,8	12,4	11,4	11,0	9,5	8,3
56,0					13,4		12,1	12,1	12,1	11,9	11,2	10,9	9,5	8,1
58,0							11,6	11,7	11,4	11,5	10,8	10,8	9,5	8,0
60,0							11,0	11,2	10,8	11,0	10,4	10,6	9,3	7,9
62,0							10,5		10,3	10,5	10,0	10,2	9,1	7,7
64,0									9,8	10,1	9,6	9,9	8,8	7,6
66,0									9,4	9,6	9,2	9,5	8,5	7,5
68,0									8,9		8,8	9,1	8,3	7,5
70,0											8,4	8,7	8,0	7,4
72,0												8,0	7,7	7,3
74,0												7,6	7,3	7,2
76,0													7,0	7,1
78,0													6,7	6,9
80,0														6,3

**Mega-Wing-Lift**

Luffing jib • Wippspitzenausleger • Volée variable • Plumín de angulación variable • Jib a volata variable



70°  
35,3 + 2,9 m



25 - 73  
0°/22° \*



8,9 m



360°



160 t



DIN/ISO

m		35,3 + 2,9											
m	25	31	37	43	49	55		61		67		73	
	0°	0°	0°	0°	0°	0°	22°	0°	22°	0°	22°	0°	22°
28,0	46,0												
30,0	43,0	42,0											
32,0	40,0	39,5											
34,0	37,5	37,0	36,5										
36,0	35,0	34,5	34,5	32,5									
38,0		32,5	32,5	31,5	27,0								
40,0		30,5	30,5	30,0	27,0								
42,0		29,0	29,0	28,5	27,0	21,5	22,0						
44,0			27,5	27,0	26,5	21,5	22,0	18,3					
46,0			26,0	25,5	25,0	21,5	21,5	18,3					
48,0			24,5	24,0	24,0	21,0	21,5	18,3	17,7	15,3			
50,0				23,0	22,5	21,0	21,5	18,3	17,6	15,1			11,5
52,0				22,0	21,5	21,0	21,0	18,3	17,5	14,8	11,9		11,2
54,0					20,5	20,0	20,0	18,3	17,4	14,6	11,7		10,9
56,0					19,7	19,3	19,3	18,3	17,3	14,4	11,5		10,7
58,0					18,8	18,4	18,4	18,0	17,3	14,2	11,3		10,4
60,0						17,6	17,6	17,2	17,2	13,8	11,1		10,1
62,0						16,8	16,8	16,4	16,4	13,2	10,9		9,8
64,0						16,0		15,7	15,7	12,7	10,8		9,5
66,0								15,0	15,0	12,2	10,7		9,3
68,0								14,3	14,3	11,9	10,6		9,0
70,0								13,7		11,6	10,5		8,7
72,0										11,3	10,5		8,5
74,0										11,1	10,5		8,3
76,0										10,9			8,1
78,0													7,9
80,0													7,7
82,0													7,5



70°  
45,0 + 2,9 m



25 - 73  
0°/22° \*



8,9 m



360°



160 t



DIN/ISO

m		45,0 + 2,9											
m	25	31	37	43	49	55		61		67		73	
	0°	0°	0°	0°	0°	0°	22°	0°	22°	0°	22°	0°	22°
32,0	37,5												
34,0	35,0	32,5											
36,0	33,0	31,5											
38,0	31,0	30,5	28,0										
40,0	29,5	29,0	27,5	24,5									
42,0		27,5	26,5	24,5	23,5								
44,0		26,0	25,5	24,0	22,5								
46,0		24,5	24,5	24,0	22,0	18,0	20,0						
48,0			23,0	22,5	21,5	18,0	19,8	16,8					
50,0			22,0	21,5	21,0	18,0	19,3	16,8					
52,0			21,0	20,5	20,0	18,0	19,0	16,8	16,8	14,1			
54,0				19,5	19,1	18,0	18,4	16,7	16,8	14,1			11,0
56,0					18,2	17,6	17,5	16,4	16,6	14,1			10,8
58,0					17,3	16,7	16,7	16,2	16,3	14,0	11,5		10,6
60,0					16,5	15,9	15,9	15,5	15,5	13,8	11,3		10,4
62,0					15,8	15,2	15,1	14,8	14,8	13,7	11,2		10,1
64,0						15,0		14,1	14,1	13,5	11,0		9,9
66,0								13,8	13,8	13,1	10,9		9,6
68,0								13,2		12,8	10,7		9,4
70,0										12,3	10,6		9,1
72,0										11,7	10,5		8,9
74,0										11,2	10,5		8,7
76,0										10,7	10,4		8,4
78,0											10,3		8,3
80,0											9,6		8,1
82,0													7,9
84,0													7,7
86,0													7,6

40

**Mega-Wing-Lift**  
**Luffing jib • Wippspitzenausleger • Volée variable • Plumín de angulación variable • Jib a volata variable**



70°  
49,8 + 2,9 m



25 - 73  
0°/22° \*



8,9 m



360°



160 t



DIN/ISO

m		49,8 + 2,9												
m	25	31	37	43	49	55		61		67		73		
	0°	0°	0°	0°	0°	0°	22°	0°	22°	0°	22°	0°	22°	
34,0	33,5													
36,0	32,0	28,0												
38,0	30,5	27,5												
40,0	29,0	26,5	24,0											
42,0	27,0	25,5	23,5	21,0										
44,0		25,0	23,0	20,5										
46,0		23,5	22,5	20,0	19,3									
48,0		22,5	21,5	19,7	19,0	16,0	16,9							
50,0			20,5	19,2	18,6	16,0	16,7							
52,0			19,7	18,6	18,2	16,0	16,4	14,7						
54,0			18,7	17,8	17,9	16,0	16,1	14,4	14,6	13,0				
56,0				17,0	17,4	15,7	15,8	14,2	14,3	12,8				
58,0				16,2	16,6	15,4	15,5	13,9	14,1	12,6			10,3	
60,0					15,8	15,2	15,2	13,7	13,9	12,4	11,3		10,2	
62,0					15,1	14,5	14,4	13,5	13,7	12,1	11,2		10,0	
64,0					14,4	13,8	13,8	13,3	13,4	11,9	11,0	9,8	8,2	
66,0					13,7	13,2	13,1	12,7	12,8	11,7	10,9	9,7	8,1	
68,0						12,6	12,5	12,1	12,2	11,4	10,8	9,5	7,9	
70,0							12,0	11,6	11,6	11,1	10,7	9,2	7,8	
72,0								11,0	11,1	10,7	10,5	9,0	7,7	
74,0								10,5	10,6	10,3	10,4	8,8	7,6	
76,0									10,1		9,8	10,1	8,6	7,4
78,0									9,6		9,4	9,6	8,4	7,4
80,0											9,0	9,2	8,2	7,3
82,0											8,5		8,0	7,2
84,0													7,8	7,2
86,0													7,6	7,2
88,0														7,2



70°  
54,6 + 2,9 m



25 - 73  
0°/22° \*



8,9 m



360°



160 t



DIN/ISO

m		54,6 + 2,9												
m	25	31	37	43	49	55		61		67		73		
	0°	0°	0°	0°	0°	0°	22°	0°	22°	0°	22°	0°	22°	
36,0	26,5													
38,0	24,0	22,5												
40,0	23,0	21,5												
42,0	22,0	20,0	19,1											
44,0	20,5	19,2	18,2	17,0										
46,0		18,3	17,3	16,2										
48,0		17,3	16,5	15,4	16,0									
50,0		16,5	15,7	14,7	15,3									
52,0			14,9	14,0	14,7	13,7	14,2							
54,0			14,2	13,1	13,9	12,3	13,0	11,6						
56,0			13,5	12,1	12,8	11,8	11,9	11,2	11,4	10,5				
58,0				11,3	12,1	11,3	11,4	10,7	10,9	10,1				
60,0				10,7	11,6	10,9	11,0	10,3	10,5	9,8			9,1	
62,0					11,1	10,4	10,5	9,9	10,1	9,4	9,7		8,7	
64,0					10,6	10,0	10,1	9,5	9,7	9,1	9,3		8,4	
66,0					10,1	9,6	9,6	9,1	9,3	8,7	9,0		8,1	8,2
68,0						9,2	9,2	8,8	8,9	8,4	8,6		7,9	8,0
70,0					9,7			8,4	8,6	8,0	8,3		7,6	7,8
72,0						8,8	8,8	8,1	8,2	7,7	7,9		7,3	7,5
74,0								7,7	7,9	7,4	7,6		7,0	7,2
76,0								7,4	7,6	7,1	7,3		6,7	7,0
78,0								7,0		6,8	7,0		6,4	6,7
80,0									6,7	6,5	6,7		6,1	6,4
82,0										6,2	6,5		5,9	6,1
84,0										5,9			5,6	5,8
86,0													5,4	5,6
88,0													5,1	5,4
90,0														4,9

GMK7450



**Mega-Wing-Lift**

Luffing jib • Wippspitzenausleger • Volée variable • Plumín de angulación variable • Jib a volata variable



60°  
35,3 + 2,9 m



25 - 73  
0°/22° \*



8,9 m



360°



160 t



DIN/ISO

m		35,3 + 2,9											
m	25	31	37	43	49	55		61		67		73	
	0°	0°	0°	0°	0°	0°	22°	0°	22°	0°	22°	0°	22°
36,0	31,5												
38,0	29,5												
40,0	28,0	27,5											
42,0	26,5	26,0											
44,0		24,5	24,0										
46,0		23,0	23,0										
48,0		22,0	21,5	21,0									
50,0			20,5	19,9									
52,0			19,5	18,9	18,5								
54,0			18,5	18,0	17,5								
56,0				17,1	16,7	16,0	16,0						
58,0				16,3	15,9	15,2	15,2						
60,0					15,1	14,5	14,5	14,0					
62,0					14,4	13,8	13,8	13,3	13,3				
64,0					13,7	13,1	13,1	12,7	12,7	12,4			
66,0						12,5	12,5	12,1	12,1	11,8	11,1		
68,0						11,9	11,9	11,5	11,5	11,2	10,9	9,8	
70,0						11,4		11,0	11,0	10,7	10,8	9,5	
72,0								10,5	10,5	10,2	10,4	9,2	7,7
74,0								10,0	10,0	9,7	10,0	9,0	7,6
76,0								9,5		9,3	9,5	8,7	7,5
78,0										8,8	9,1	8,5	7,4
80,0										8,4	8,6	8,2	7,3
82,0										8,0		7,9	7,2
84,0												7,5	7,2
86,0												7,1	7,1
88,0												6,8	



60°  
45,0 + 2,9 m



25 - 73  
0°/22° \*



8,9 m



360°



160 t

















DIN/ISO

m		45,0 + 2,9											
m	25	31	37	43	49	55		61		67		73	
	0°	0°	0°	0°	0°	0°	22°	0°	22°	0°	22°	0°	22°
42,0	24,0												
44,0	22,5												
46,0	21,5	21,0											
48,0	20,0	19,7											
50,0		18,7	18,1										
52,0		17,7	17,2	16,5									
54,0		16,7	16,3	15,6									
56,0			15,5	14,8									
58,0			14,8	14,1	13,6								
60,0			14,0	13,4	12,9								
62,0				12,8	12,3	11,8	11,8						
64,0				12,1	11,7	11,2	11,2						
66,0					11,1	10,7	10,6	10,2					
68,0					10,6	10,1	10,1	9,7	9,7				
70,0					10,1	9,6	9,6	9,2	9,2	8,9			
72,0						9,2	9,2	8,8	8,8	8,5	8,5	8,0	
74,0						8,7	8,7	8,3	8,3	8,0	8,1	7,6	
76,0						8,3		7,9	7,9	7,6	7,7	7,2	
78,0								7,5	7,5	7,3	7,3	6,8	6,9
80,0								7,1	7,1	6,9	6,9	6,5	6,5
82,0								6,8		6,5	6,6	6,1	6,2
84,0										6,2	6,2	5,8	5,8
86,0										5,9	5,9	5,5	5,5
88,0										5,5		5,2	5,2
90,0												4,9	4,9
92,0												4,6	4,7

42

**Mega-Wing-Lift**  
**Luffing jib • Wippspitzenausleger • Volée variable • Plumín de angulación variable • Jib a volata variable**

	60° 49,8 + 2,9 m		25 - 73 0°/22° *		8,9 m		360°		160 t				
	 <b>DIN/ISO</b>												
<b>m</b>													
<b>49,8 + 2,9</b>													
m	25	31	37	43	49	55		61	67	73			
	0°	0°	0°	0°	0°	0°	22°	0°	22°	0°	22°		
44,0	21,5												
46,0	20,5												
48,0	19,3	18,7											
50,0	18,3	17,7											
52,0		16,8	16,2										
54,0		15,9	15,4										
56,0		15,1	14,6	13,9									
58,0			13,9	13,2									
60,0			13,2	12,5	12,3								
62,0			12,5	11,9	11,7								
64,0				11,3	11,1	10,4							
66,0				10,8	10,5	9,8	9,8						
68,0				10,2	10,0	9,3	9,3	8,9					
70,0					9,5	8,9	8,9	8,4	8,4				
72,0					9,1	8,4	8,4	8,0	8,0	7,6			
74,0					8,6	8,0	8,0	7,6	7,6	7,2			
76,0						7,6	7,6	7,2	7,2	6,8	6,8	6,3	
78,0							7,2	6,8	6,8	6,5	6,5	6,0	
80,0								6,4	6,5	6,1	6,1	5,6	
82,0								6,1	6,1	5,8	5,8	5,3	5,4
84,0								5,8		5,5	5,5	5,0	5,0
86,0								5,4		5,2	5,2	4,7	4,8
88,0										4,9	4,9	4,4	4,5
90,0										4,6		4,1	4,2
92,0												3,9	3,9
94,0												3,6	3,7
96,0												3,4	

	60° 54,6 + 2,9 m		25 - 73 0°/22° *		8,9 m		360°		160 t				
	 <b>DIN/ISO</b>												
<b>m</b>													
<b>54,6 + 2,9</b>													
m	25	31	37	43	49	55		61	67	73			
	0°	0°	0°	0°	0°	0°	22°	0°	22°	0°	22°		
48,0	18,4												
50,0	17,4												
52,0	16,4	15,7											
54,0	15,5	15,0											
56,0		14,2	13,3										
58,0		13,5	12,6	10,8									
60,0			11,4	10,4									
62,0			10,9	9,9									
64,0				9,5	10,2								
66,0				9,1	9,7								
68,0				8,6	9,2	8,5	8,5						
70,0				8,2	8,8	8,1	8,1						
72,0					8,3	7,7	7,6	7,2					
74,0					7,9	7,3	7,2	6,8	6,8				
76,0					7,5	6,9	6,9	6,4	6,4	6,0			
78,0						6,5	6,5	6,1	6,1	5,7	5,1		
80,0						6,1	6,1	5,7	5,7	5,4	5,4	4,8	
82,0						5,8		5,4	5,4	5,0	5,1	4,5	
84,0								5,1	5,1	4,7	4,8	4,2	4,3
86,0								4,8	4,8	4,5	4,5	3,9	4,0
88,0								4,5		4,2	4,2	3,6	3,7
90,0										3,9	3,9	3,4	3,5
92,0										3,7	3,7	3,1	3,2
94,0										3,4		2,9	3,0
96,0												2,7	2,8
98,0												2,5	2,5

GMK7450



Axles  
Achsen  
Ponts  
Ejes  
Assali



Crane functions  
Kranbewegungen  
Mouvements de la grue  
Funciones de la grúa  
Funzioni della gru



Hookblock / Capacity  
Hakenflasche / Traglast  
Moufle / Force de levage  
Gancho / Capacidad  
Gancio / Capacità



Speed  
Geschwindigkeit  
Vitesse  
Velocidad  
Velocità



Axle load  
Achslast  
Charge à l'essieu  
Carga por eje  
Carico sugli assi



Crane travel  
Fahrstellung  
Déplacement de la grue  
Grúa en traslado  
Traslazione gru



Hydraulic system  
Hydrauliksystem  
Circuit hydraulique  
Sistema hidráulico  
Impianto idraulico



Suspension  
Federung  
Suspension  
Suspensión  
Sospensioni



Boom  
Ausleger  
Flèche  
Pluma  
Braccio



Drive/Steer  
Antrieb/Lenkung  
Direction/Déplacement  
Tracción/Dirección  
Trazione/Sterzo



Lattice extension  
Gitterspitze  
Extension treillis  
Extensión de celosía  
Lunghezza prolunga



Transmission / Gear  
Getriebe / Gang  
Boîte de vitesses / Rapport  
Transmisión / Cambio  
Cambio



Boom elevation  
Wippwerk  
Relevage  
Elevacion de pluma  
Elevazione braccio



Electrical system  
Elektrische Anlage  
Circuit électrique  
Sistema eléctrico  
Impianto elettrico



Lattice extension (luffing)  
Auslegerverlängerung (wippbar)  
Extension treillis (volée variable)  
Extensión de celosía (angulable hidráulicamente)



Travel speed  
Fahrgeschwindigkeit  
Vitesse de déplacement  
Velocidad de desplazamiento  
Velocità di traslazione



Boom telescoping  
Teleskopieren  
Télescopage de flèche  
Telescopaje de pluma  
Lunghezza braccio



Engine  
Motor  
Moteur  
Motor  
Motore



Luffing Jib  
Wippspitzenausleger  
Volée variable  
Plumín angulable



Tyres  
Bereifung  
Pneumatiques  
Neumáticos  
Pneumatici



Brakes  
Bremsen  
Freins  
Frenos  
Freni



Free on wheels  
Freistehend  
Sur pneus  
Sobre neumáticos  
Su gomme



Low range  
Kleinste Übersetzung  
Gamme basse  
Marchas cortas  
Fuoristrada



Cab  
Kabine  
Cabine  
Cabina  
Cabina



Gradeability  
Steigfähigkeit  
Aptitude en pente  
Superacion de pendientes  
Pendenza superabile



Outriggers  
Abstützung  
Calage  
Estabilizadores  
Stabilizzatori



Carrier frame  
Rahmen  
Châssis porteur  
Bastidor  
Telaio



Main hoist  
Haupthubwerk  
Treuil principal  
Cabrestante principal  
Argano principale



Radius  
Ausladung  
Portée  
Radio  
Raggio



Counterweight  
Gegengewicht  
Contrepoids  
Contrapeso  
Contrappeso



Auxiliary hoist  
Hilfshubwerk  
Treuil auxiliaire  
Cabrestante auxiliar  
Argano secundario



Slewing/Working range  
Drehwerk/Arbeitsbereich  
Orientation/Rayon d'operation  
Giro/Gama de trabajo  
Rotazione/Area di lavoro



#### **Manitowoc Crane Group - Americas**

Manitowoc, Wisconsin Facility

Tel: [Int + 001] 920 684 6621

Fax: [Int + 001] 920 683 6277

Shady Grove, Pennsylvania Facility

Tel: [Int + 001] 717 597 8121

Fax: [Int + 001] 717 597 4062

#### **Manitowoc Crane Group - EMEA**

Europe Middle East & Africa

Tel: [Int + 33] (0) 4 72 18 20 20

Fax: [Int + 33] (0) 4 72 18 20 00

#### **Manitowoc Crane Group - UK**

Europe Middle East & Africa (Parts & Service)

Tel: [Int + 44] (0) 191 565-6281

Fax: [Int + 44] (0) 191 564-0442

#### **Manitowoc Crane Group - Germany**

(Sales, Parts & Service)

Tel: [Int + 49] (0) 2173 8909-0

Fax: [Int + 49] (0) 2173 8909-30

#### **Manitowoc Crane Group - France**

France & Africa (Sales, Parts & Service)

Tel: [Int + 33] (0) 1 303-13150

Fax: [Int + 33] (0) 1 303-86085

#### **Manitowoc Crane Group - Netherlands**

(Sales, Parts & Service)

Tel: [Int + 31] (0) 76 578 39 99

Fax: [Int + 31] (0) 76 578 39 78

#### **Manitowoc Crane Group - Italy**

Italy & Southern Europe (Sales, Parts & Service)

Tel: [Int + 39] (0) 331 49 33 11

Fax: [Int + 39] (0) 331 49 33 30

#### **Manitowoc Crane Group - Portugal**

Portugal & Spain (Sales, Parts & Service)

Tel: [Int + 351] (0) 22 968 08 89

Fax: [Int + 351] (0) 22 968 08 97

#### **Manitowoc Crane Group - Singapore**

Asia/Pacific excl China (Sales, Parts & Service)

Tel: [Int + 65] 6861-7133

Fax: [Int + 65] 6862-4040 / 4142

#### **Manitowoc Crane Group - Shanghai**

China (Sales, Parts & Service)

Tel: [Int + 86] (0) 21-64955555

Fax: [Int + 86] (0) 21-64852038

#### **Manitowoc Crane Group - Beijing**

China (Sales, Parts & Service)

Tel: [Int + 86] (0) 10 646-71690

Fax: [Int + 86] (0) 10 646-71691

#### **Manitowoc Crane Group - Middle East**

(Sales)

Tel: [Int + 971] (0) 4 348-4478

Fax: [Int + 971] (0) 4 348-4478

(Parts & Service)

Tel: [Int + 973] (0) 9 660-899

Fax: [Int + 973] (0) 2 707-740

**Distributed By:**



[www.manitowoccrane.com](http://www.manitowoccrane.com)

Constant improvement and engineering progress make it necessary that we reserve the right to make specification, equipment, and price changes without notice. Illustrations shown may include optional equipment and accessories and may not include all standard equipment.

Wir verbessern unsere Produkte ständig und integrieren den technischen Fortschritt. Aus diesem Grund behalten wir uns das Recht vor, die technischen Daten, die Ausstattungsdetails und die Preise unserer Maschinen ohne Vorankündigung zu ändern.

Du fait de sa politique d'amélioration constante de ses produits liée au progrès technique, la Société se réserve le droit de procéder sans préavis à des changements de spécifications, d'équipement ou de prix. Les illustrations peuvent comporter des équipements ou accessoires optionnels ou ne pas comporter des équipements standards.

El perfeccionamiento constante y el avance tecnológico hacen necesario que la empresa se reserve el derecho de efectuar cambios en las especificaciones, equipo y precios sin previo aviso. En las ilustraciones se puede incluir equipo y accesorios opcionales y es posible que no se muestre el equipo normal.

Dati e caratteristiche possono variare senza obbligo di preavviso.